

# NUMERICAL UNDER/OVER & UNBALANCE PROTECTION RELAY AR39 [AN+ SERIES]



# USER MANUAL



**ALUMINIUM INDUSTRIES LIMITED  
RELAYS DIVISION, THIRUVANANTHAPURAM**

# AR39

## Numerical OV, UV and Voltage unbalance Protection Relay

### CONTENTS

SAFETY REQUIREMENTS	AR39-I
<hr/>	
INTRODUCTION	AR39-II
<hr/>	
HANDLING INSTALLATIONS & CASE DIMENSIONS	AR39-III
<hr/>	
USER GUIDE	AR39-IV
<hr/>	
TECHNICAL DATA & CHARACTERISTIC CURVES	AR39-V
<hr/>	
TROUBLE SHOOTING	AR39-VI
<hr/>	
COMMUNICATION	AR39-VII
<hr/>	

# **SAFETY REQUIREMENTS**

## CONTENTS

INTRODUCTION

---

HEALTH AND SAFETY

---

SYMBOLS AND EXTERNAL LABELS ON THE RELAY

---

INSTALLING, COMMISSIONING AND SERVICING

---

DECOMMISSIONING AND DISPOSAL

---

TECHNICAL SPECIFICATION FOR SAFETY

---

## INTRODUCTION

Before using this product, be sure to read this chapter carefully.

This chapter describes safety precautions when using the relay. Before installing and using the equipment, read and understand this chapter thoroughly.

It's not a secret – electricity can be dangerous and when things go wrong lives can be at stake!

Electrical engineers are Industrial safety doctors, so it's our duty to keep employees health and maintain a quality of life that we all deserve by providing safe work practices to avoid electrical accidents.

### How much electricity is dangerous?????

CURRENT	EFFECT
0.5 – 3mA	Tingling sensations
3 – 10mA	Muscle contractions (painful)
10 – 40mA	"can't let go" phenomena
40 – 75mA	Respiratory paralysis (possibly fatal)
75 – 200mA	Ventricular fibrillation (likely fatal)
200 – 500mA	Heart clamps tight
>1.5A	Tissue and organs began to burn

**Fact: A 15 amp circuit breaker was designed to protect equipment – not people!**

The relay is developed with zero percentage of risk factor by its own design. The current carrying paths and circuits are isolated from the metal case and structure. Suitable clearance depending on the type of insulation required for different classes are provided.

The relay confirms to Product safety requirement standard IEC 60255-27.

## HEALTH AND SAFETY

It deals with the handling of relay in proper way. An individual to be considered as 'qualified' with regard to certain equipment in the workplace, but 'unqualified' as to other equipment. "An employee, who is undergoing on the job training and who, in the course of such training, has demonstrated the ability to perform duties safely at his or her level of training and who is under the direct supervision of a qualified person also considered to be a qualified person for the performance of those duties."

The following requirements must be met, in the order given, before circuits or equipments are re-energized, even temporarily.

- ✚ People handling the equipment should be aware about the relay safety handlet.
- ✚ Ensure that the product is in the off condition before working on the conducting or terminal side.
- ✚ A qualified person must conduct tests and visual inspections, as necessary, to verify that tools electrical jumpers, shorts, grounds and other such devices have been removed, so that the circuits and equipments can be safely re-energized.
- ✚ Employees exposed to the hazards associated with re-energizing the circuit or equipment must be warned to stay clear of the circuits and equipment.
- ✚ Each lock and tag must be removed by the employee who applied it or someone else under that employee's direct supervision.
- ✚ A visual determination that all employees are clear of the circuits and equipments must be made.

For any queries related to relays, feel free to contact ALIND.

## SYMBOLS AND LABELS USED IN THE RELAY

### 1. FRONT SIDE



Caution: refer to equipment documentation



Caution: risk of electric shock



Caution: Over voltage Cat.III

### 2. REAR SIDE



#### WARNING

1. No user serviceable components inside.
2. Refer servicing to authorized personnel.



Protective Conductor (\*Earth) terminal  
Functional/Protective Conductor (\*Earth) terminal.



CMOS Battery provided for the RTC (Real Time Clock) purpose. Confirm polarity of the battery while replacing.



IEC 61850 sticker

**WARNING****Current transformer circuit**

Never allow the current transformer (CT) secondary circuit connected to this equipment to be opened while the primary system is live. Opening the CT circuit will produce a dangerous high voltage.

**Exposed terminals**

Do not touch the terminals of this equipment while the power is on, as the high voltage generated is dangerous.

**Residual voltage**

Hazardous voltage can be present in the DC circuit just after switching off the DC power supply. It takes about 30 seconds for the voltage to discharge.

**CAUTION****Earth**

Earth the earthing terminal of the equipment securely.

**Operation conditions**

Use the equipment within the range of ambient temperature, humidity and dust as detailed in the specification and in an environment free of abnormal vibration.

**Ratings**

Before applying AC voltage and current or DC power supply to the equipment, check that they conform to the equipment ratings.

**Printed circuit board**

Do not attach and remove the printed circuit board while the DC power to the equipment is on, as this may cause the equipment to malfunction.

**External circuit**

When connecting the output contacts of the equipment to an external circuit, carefully check the supply voltage used and prevent the connected circuit from overheating.

**Connection cable**

Carefully handle the connection cable without applying excessive force.





### Modification

Do not modify this equipment, as this may cause the equipment to malfunction, and in any such cases, warranty may be affected.

## DECOMMISSIONING AND DISPOSAL

### De-commissioning



The supply input (auxiliary) for the equipment may include capacitors across the supply or to earth. To avoid electric shock or energy hazards, after completely isolating the supplies to the equipment, the capacitors should be safely discharged via the external terminals prior to de-commissioning.



### Disposal

When disposing of this equipment, do so in a safe manner according to local regulations. It is recommended that incineration and disposal to water courses is avoided. Ensure the relay is in de energized condition and take precautions to avoid short circuits.

## TECHNICAL SPECIFICATIONS FOR SAFETY

### 1. Protective class

IEC 60255-27:2005	Class I	(This equipment requires a protective conductor (earth) connection to ensure user safety.)
-------------------	---------	--

### 2. Environment

IEC 60255-27:2005	Pollution degree 2	(Normally only non-conductive pollution occurs except occasionally a temporary conductivity caused by condensation is to be expected.)
-------------------	--------------------	--

### 3. Overvoltage Category

IEC 60255-27:2005	Category III	(The auxiliary energizing circuits of the equipment are connected to a common battery, common mode transient voltages of a relatively high value may appear on the supply leads, and differential mode voltages may arise from switching in other circuits connected to the same battery source.)
-------------------	--------------	---

### 4. Contact data

Test voltage across open contact: 1 kV DC for 1 min source.

# INTRODUCTION

**CONTENTS**

AN SERIES DESCRIPTION

---

PREVIOUS HISTORY OF CAPACITOR BANK PROTECTION RELAYS

---

BRIEF DESCRIPTION OF AR39

---

MAIN FUNCTIONS

---

GENERAL FUNCTIONS

---

**AN+ SERIES (ALIND NUMERICAL SERIES)**

- ❖ Advanced Digital Fourier Transform based Numerical algorithm design using 32-bit Digital Signal Controller.
- ❖ Compact Construction covering several protection modules viz Over Current Protection, Earth Fault/ Restricted Earth Fault protection along with Trip Circuit supervision in single module thus saving panel space.
- ❖ Display of protection acted, fault current, fault clearing time, fault date & time of latest 200 faults at Relay LCD.
- ❖ Man-Machine Communication through 20x4 character LCD display.
- ❖ Self-supervision of both hardware and software units.
- ❖ Interface ability with SCADA through IEC 60870-5-103 & IEC 61850 communication protocol
- ❖ Facility for storing fault waveforms (Disturbance recorder) and events with date and time stamping. At a time, a total of 5000 events and 200 latest fault waveform (Disturbance recorder) will be stored in the relay.
- ❖ Graphical User Interface for Harmonic analysis, DC analysis and di/dt analysis can be done on the uploaded fault waveforms with facility for report generation.
- ❖ Facility to access/modify the relay settings both online as well as through menu in local PC
- ❖ Relay Indication (LED) reset from RCC
- ❖ IP 54 grade enclosure protection.
- ❖ SNTP (Simple Network Time Protocol) & optional GPS based IRIG -B time code standard Synchronization Facility.
- ❖ Online HV current & LV current display on relay LCD.
- ❖ Settable CT ratios.
- ❖ Relay operation Counter

**PREVIOUS HISTORY OF CAPACITOR BANK RELAYS****AFC 204**

*Numerical Capacitor Bank relay*

*Disturbance & event recorder.*

***Built in counter facility.***

**ANC 214:**

The relay conforms to RDSO specification No. TI/SPC/PSI/PROTCT/6071. ANC 214 (AN Series) relay is a comprehensive Integrated Capacitor Bank Protection relay for the protection of conventional 27 KV AC single phase, 50Hz Over Head Equipment (OHE).

**ANC 402/ 033:**

The relay conforms to RDSO specification No. TI/SPC/PSI/PROTCT/7100(07/2012). ANC 402/ 033 (AN Series) relay is a comprehensive Integrated Feeder Protection relay for the protection of 2x 25 KV (AT feeding system) AC single phase, 50Hz Over Head Equipment (OHE).

Designed as per RDSO specification no. TI/SPC/PSI/PROTCT/7101 and 6072.

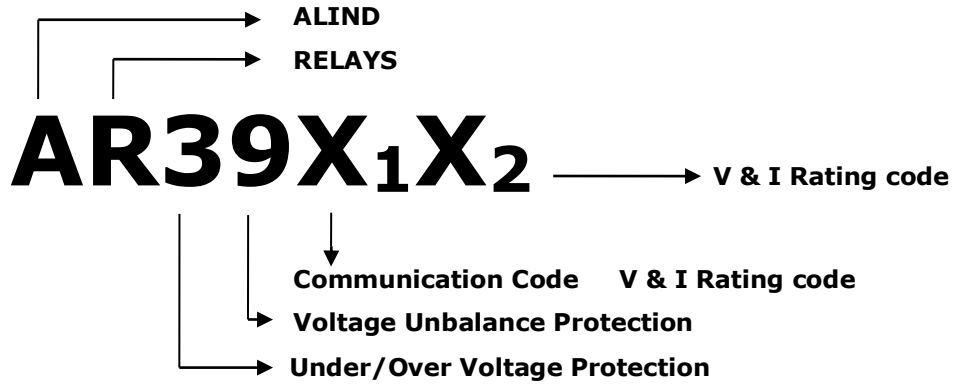

Protection naming codes	
0.	None
1.	Panto Flash Over Protection
2.	Distance Protection
3.	Under/Over Voltage Protection
4.	Current Unbalance Protection
5.	Over Current Protection
6.	EF/REF Protection
7.	Delta I Protection
8.	Current Differential Protection
9.	Voltage Unbalance Protection

Communication naming codes- X <sub>1</sub>	
A	IEC 60870-5-103
B	IEC 60870-5-103 + IEC61850 (RJ45)
C	IEC 60870-5-103 + IEC61850 (LC)
D	IEC 60870-5-103 + IEC61850 (Redundant RJ45)
E	IEC 60870-5-103 + IEC61850 (Redundant LC)
F	IEC 60870-5-103 + IEC61850 (Redundant RJ45) + IRIG B
G	IEC 60870-5-103 + IEC61850 (Redundant LC) + IRIG B
H	IEC 60870-5-103 + IRIG B
I	IEC 60870-5-103 + IEC61850 (RJ45) + IRIG B
J	IEC 60870-5-103 + IEC61850 (LC) + IRIG B

V & I Rating codes-X <sub>2</sub>	
1	1A CT
2	110V AC& 1A
3	110V AC& 5A
4	230V AC& 110V DC
5	5A CT
6	100AC& 1A
7	100AC& 5A
8	100AC
9	110V AC

**MAIN FUNCTIONS**

SI No.	PARTICULARS	AR39
<b>1</b>	<b>MAIN PROTECTIONS</b>	
1.1	Over Voltage Protection	✓
1.2	Under Voltage Protection	✓
1.3	Unbalance Protection	✓
1.4	Time Delay Relay	✓
1.5	LBB	✓
1.6	Relay Error	✓
<b>2.</b>	<b>STATUS INPUTS</b>	
2.1	Trip Circuit Supervision	✓
2.2	AP/GP Low Alarm	✓
2.3	AP/GP Low Trip & Lock	✓
2.4	Breaker status NC	✓
2.5	Breaker status NO	✓
2.6	RCC reset	✓

**GENERAL FUNCTIONS**

SI No.	PARTICULARS	AR39
1.	Password protection	✓
2.	Event Memory	5000
3.	Disturbance recorder waveforms	200
4.	50 cycles (45 pre and 5 post fault) of fault waveform	✓
5.	<b>COMMUNICATION</b>	
5.1	GUI Interface	RJ45
5.2	Isolated RS 485 Interface	✓
5.3	Communication Protocol Interface- IEC 60870-5-103 & IEC 61850	✓
5.4	GPS Time Sync Facility through IRIG-B	✓
5.5	Date/time synchronization through PC	✓
5.6	Relay programming through Mini USB port	✓
6.	<b>MONITORING</b>	
6.1	Line Current (IDMT)	✓
6.2	Unbalance Current	✓
6.5	Counters for each element	✓
7.	<b>USER INTERFACE</b>	
7.1	Test facility in Relay setting Mode (offline)	✓
7.2	Compact Module	✓
7.3	Plug In Type	✓

# HANDLING INSTALLATIONS & CASE DIMENSIONS



## CONTENTS

HANDLING OF RELAY

---

STORAGE

---

RELAY AND RACK MOUNTING

---

CASE DIMENSIONS

---

## **HANDLING OF RELAY**

Protective relays generally of robust construction require careful treatment prior to installation on site. Care must be taken when unpacking and installing the relays so that none of the parts are damaged. Relays must be handled by skilled personnel. The following should be taken into account while handling the relay:

- ✚ The relay use components that are sensitive to electrostatic discharges. The relay comprises of various semi-conductor devices which can damage if touched by means of direct contact. Handle the cards in static free environment since electrostatic discharge can affect performance of the relay or cause damage to the cards.
- ✚ The electronic circuits are well protected by the metal case and the internal module should not be withdrawn unnecessarily.
- ✚ The relay is normally shipped in separately packed condition. After unpacking, see if there is any mechanical damage to the cabinet, the nameplate, terminal blocks etc. Damage of any such sort identified shall be intimated to works.
- ✚ Avoid plugging in/ pulling out the cards when the power is ON.
- ✚ Do not apply CT inputs when auxiliary supply is switched OFF.
- ✚ If the cards are withdrawn for testing, ensure proper positioning while replacing.
- ✚ Keep the relays in well-packed condition in a dust-free dry environment without direct exposure to sunlight.

The relay is shipped from factory after detailed testing by our Quality Control Department. However, according to the customer requirement the relay settings/ functions can be verified before commissioning at respective sites with proper testing kits.

## **STORAGE**

If relays are not to be installed immediately upon receipt they should be stored in a place free from dust and moisture in their original boxes. At most care should be taken while storage.

Storage temperature: -25°C to +55°C.

RELAY AND RACK MOUNTING

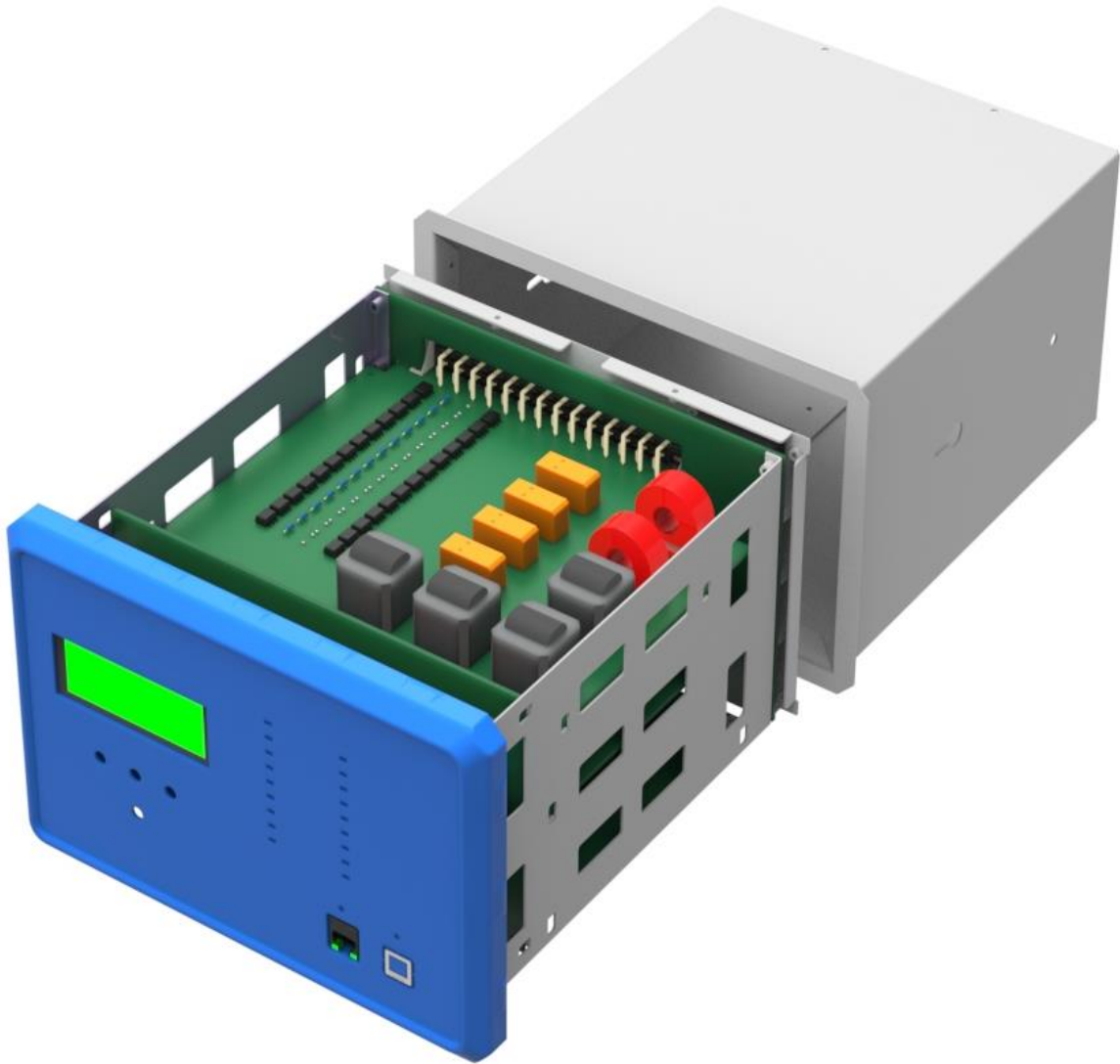

CASE DIMENSIONS

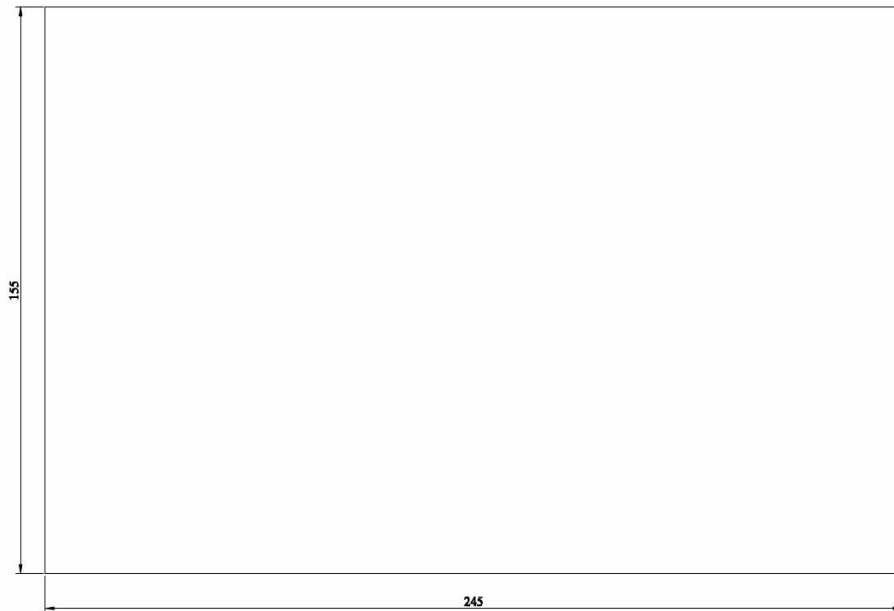
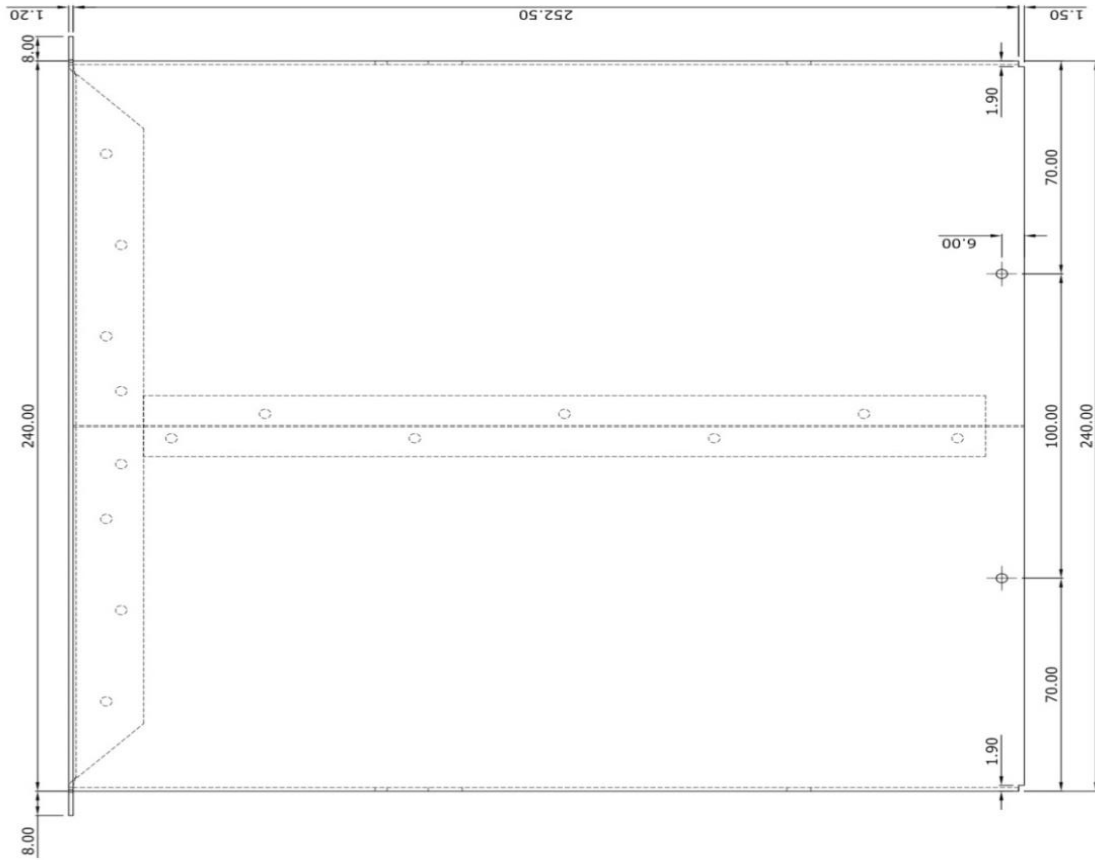

CUT OUT DETAILS

# USER GUIDE



## CONTENTS

FRONT PANEL INDICATIONS

---

INTERNAL ARCHITECTURE AND BLOCK DIAGRAM

---

ENERGIZING THE RELAY

---

PCB DESCRIPTION

---

RELAY SETTINGS AND ALGORITHM

---

FRONT PANEL INDICATIONS

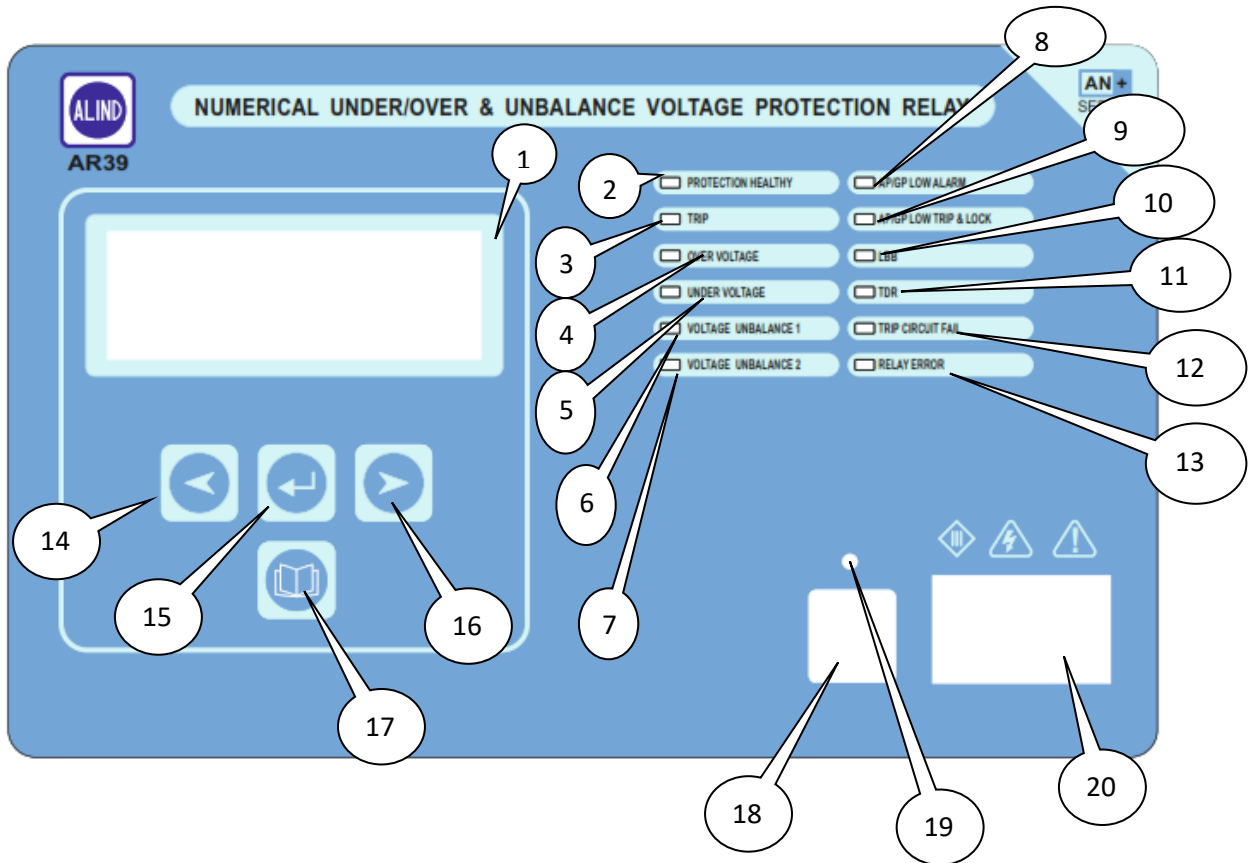

No	Legend
1.	LCD DISPLAY
2.	PROTECTION HEALTHY (Green/Amber)
3.	TRIP (Red)
4.	OVER VOLTAGE TRIP (Red)
5.	UNDER VOLTAGE TRIP (Red)
6.	VOLTAGE UNBALANCE-1 TRIP (RED)
7.	VOLTAGE UNBALANCE-2 TRIP (RED)
8.	AP/GP LOW ALARM (Red)
9.	AP/GP LOW TRIP & LOCK (Red)
10.	LBB (Red)
11.	TDR(Red)
12.	TRIP CIRCUIT FAIL(Red)
13.	RELAY ERROR
14.	>
15.	←
16.	<
17.	Records
18.	RJ45 PORT
19.	H.RST
20.	Name plate



## LCD DISPLAY

A 20 x 4 LCD display is provided for easy viewing of parameters, relay settings, fault event records, date & time, error counter etc. The display backlight can be made ON by pressing any push button key and the display backlight ON time is settable.

## Navigation Keys

The relay is provided with four switches.

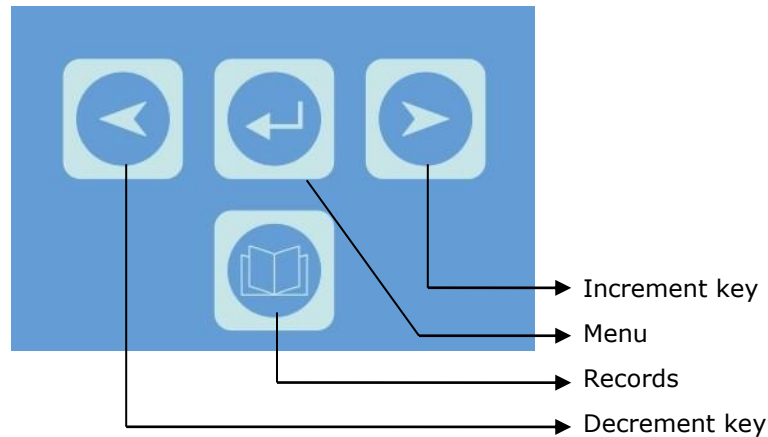

### Menu key

- \* Main key for entering relay setting mode.
- \* If you want to select anything in the setting mode, we can use this key.
- \* To reset the relay from tripping mode.

### Increment key

- \* If you want to raise any particular setting, we can use this option.
- \* For saving any particular changes in the relay, you can use this key.
- \* For viewing new options in the relay, we can use this key.

### Decrement key

- \* If you want to lower any particular setting, we can use this option.
- \* No need to save any unwanted mistakes in the relay you can use this key.
- \* If you want to verify any previous settings in the relay, you can use this key.

### Records key

- \* If you want to check the logs and data stored in the relay memory, you can use this key.

## INTERNAL SYSTEM LEVEL ARCHITECTURE

The internal system level architecture of relay including card to card architecture in brief is shown below.

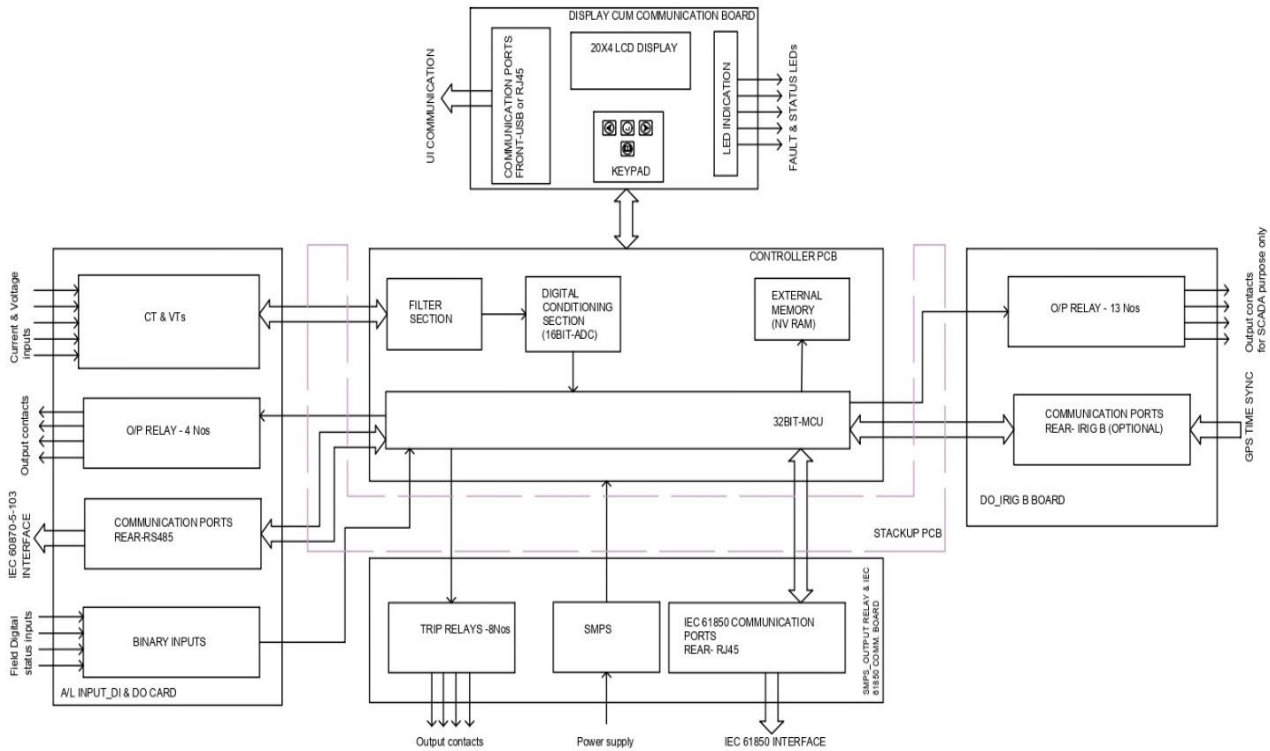

### 1.DSP Controller

The 32bit MCU (Digital Signal Controller) machine that combines the control advantages of a high-performance 32-bit microcontroller with the high computation speed of a fully implemented Digital Signal Processor (DSP).

The MCU controller continuously monitors the currents. Based on this the controller performs different calculations and whenever an abnormal condition occurs it distinguishes the type of fault and issues trip command to the circuit breaker.

### 2. Data Acquisition

The Current signals are scaled and isolated using Current Transformer (CT). These isolated analog signals are filtered to minimize the effects of electromagnetic interference and noise in the high frequency range.

The analog signals are then fed to the Analog to Digital Converter which has a 16 bit resolution. The DSP controller will take the 32 samples per cycles of Current for the computational purpose. If any fault occurs the parameters will be stored in to the non-volatile memory with date and time stampings and this can be downloaded for further analysis in the disturbance recorder.

### 3. Power Supply Module

This module gives the necessary regulated voltages like +5V, -5V, and +24V to various cards in the module. The normal operating voltage range is 45 VDC to 170 VDC. The +24V is used for driving the output relays in the I/O card and O/P relay card. The +5V and -5V is supplied to the processor, I/O card and Display PCB for normal relay operations. The isolated +5V is dedicated to the communication ports of the relay.

## 4. Communication Module

The relay is having three communications port, Front port: RJ45, Rear port: ETHERNET & RS485. The relay is using IEC 60870-5-103 & IEC 61850-communication protocol for communication through RS485 & ETHERNET.

### Front Port:

#### 1) Communication Port

RJ 45 port shall be provided for uploading/downloading relay settings and events.

### Rear Port:

#### a) RS 485 Communication Port

RS 485 port shall be provided for SCADA connectivity. Using RS485 port fault online data of critical parameters, disturbance record, and event record (Trip data) etc shall be downloaded. The communication protocol shall comply to IEC 60870-5-103 protocol.

#### b) Ethernet Communication Port

Ethernet port shall be provided for IEC 61850 connectivity. Using Ethernet port fault online data of critical parameters, disturbance record, event record (Trip data) etc. shall be downloaded. SNTP time synchronization is possible through the same. Ethernet port can either be copper/fiber depending upon the tender requirement.

## 5. Man Machine Interface

Man Machine Interface is through a 20x4 LCD display and keys in the front panel of the relay. Necessary LEDs are provided in front panel for indicating the operation of different element.

## 6. Disturbance Recorder

The relay has the facility to record 50 cycles (45 pre-fault and 5 post faults) of fault waveforms. Latest 200 waveforms of Current can be stored in the relay. This data is retrievable through front and rear communication ports using UI software and SCADA respectively.

## 7. Event Recorder & Disturbance Recorder

The relay is capable of storing 5000 number of events with date and time stamping of 1ms accuracy. The event data comprise of:

Tripping of different protection elements (I, Fault clearing time, Fault date & time)

Trip circuit supervision

Relay pick up

Relay reset

CB Trip

CB Close

Change of status input

Relay setting changed (GUI & Keypad)

Relay Error.

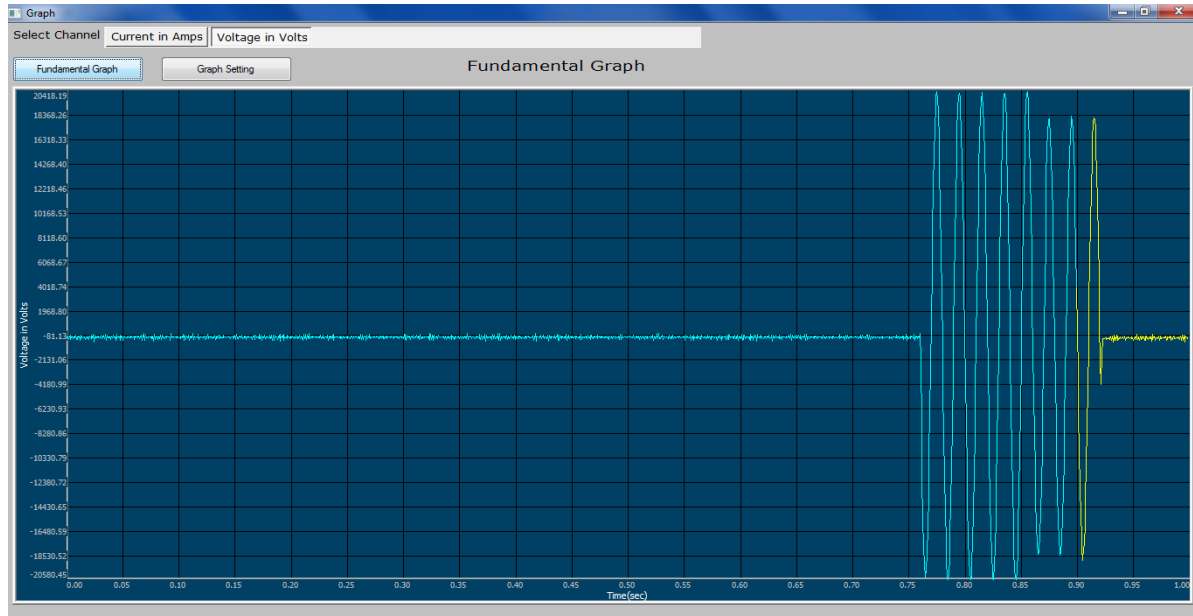

## ENERGIZING THE RELAY

1. Before turning ON the relay, proper earthing should be provided.
2. Visual Inspection for any physical damage in housing, display etc. shall be checked.
3. Operating voltage range: **45 to 170 VDC**. Rated Operating voltage: **110 V DC**.
4. Prefer regulated power supply of 110VDC.
5. Auxiliary power supply shall be provided to the corresponding terminals with the help of an MCB.
6. Switch on the power supply. Measure the voltage between the corresponding terminals and ensure that the voltage is within the normal operating range.
7. After the relay is powered ON, the following shall be noticed.

Protection healthy LED glow green in color which indicates that the relay is functioning OK, otherwise it goes amber.

## PCB DESCRIPTION

The relay comprises of the following hardware.

**Main PCBs.** –Display PCB, Controller PCB, Stack PCB, status & CT, PT PCB, SMPS & trip relay PCB, Tele Annu PCB, Back panel PCB

**Display cum Communication PCB (640 261):** The Display PCB is mounted at the front plate of the unit. It consists of the 20x4 LCD, LED indications, Keyboard circuits, LED controller and front RJ 45 communication port.

**Controller PCB (640 262):** The Controller PCB is mount on the backside of the Display PCB. This PCB consists of major components such as DSP controllers, ADC and its filter circuits, Memory ICs, RTC etc. The Analog signal get filtered and digitized in this board. The DSP takes decision based on this digital samples and initiates necessary commands.

**Stack PCB (640 263):** Internal communications between the PCB's are ensured with the help of stack PCB.

**Status & CT,PT PCB (640 264):** All the CTs, PTs and Input status lines are assembled in this board. IEC 60870-5-103 communication port also provided in this PCB.

**SMPS & Trip Relay PCB (640 265):** The SMPS PCB provides the necessary Power supply voltages to the different PCBs mounted inside the relay. The SMPS provides +24V, +5V, -5V and isolated +5 V. The +24 V supply is used for the driving the output relays. The +5V and -5V is supplied to the controller PCB, Display PCB, and I/O PCB for normal operations. The isolated +5V is dedicated to the communications ports of the relay.

This board (trip relay PCB) will give necessary trip commands to the master trip relay or breaker, which is installed in the yard. Necessary relay initiating signals are wired to these output relays from the Controller Board.

**Tele Annu PCB (640 266):** All the Telesignalling output circuits are assembled in this PCB. IRIG B circuit also provided in this PCB.

**Back Panel PCB (640 267):** This PCB consists of terminal blocks for external interface with the site and power connectors, which connects SMPS, I/O and CT PT PCB's. The RS 485 port is also mounted in this PCB. The terminal block (TB-A) is having CT shorting facility. Since the rack with Terminal Blocks is having the CT shorting facility, the relay can be withdrawn.

## RELAY ONLINE DISPLAY PARAMETERS

After Power ON, the relay boot screen shows

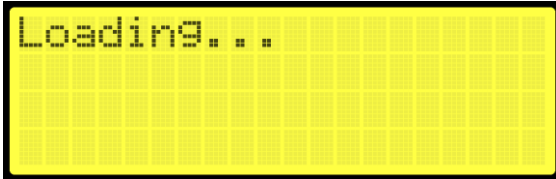

Then comes the online parameter display

Window:

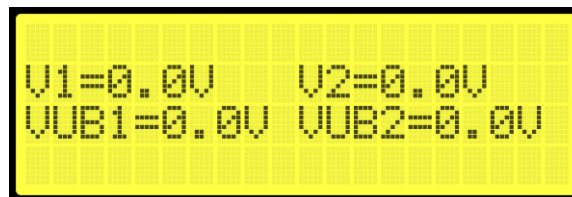

### Setting Mode

Press and hold **↵** for 5 seconds

Relay will enter to setting mode.

Change settings press **↵** key.

Enter the password and press **↵** key. The default password setting is '1000'

To change settings:

- Press **↵** to change the settings.
- Press **Right** key to increment
- Press **Left** key to decrement
- Press **↵** to accept change.
- To coming back to main **MENU** while operating, press **Left** and **Right** key simultaneously.
- Repeat the process for all settings
- After completing the settings, the relay shows the message '**SETTINGS UPDATED**' and returns to the operating mode.

### Relay Settings Algorithm

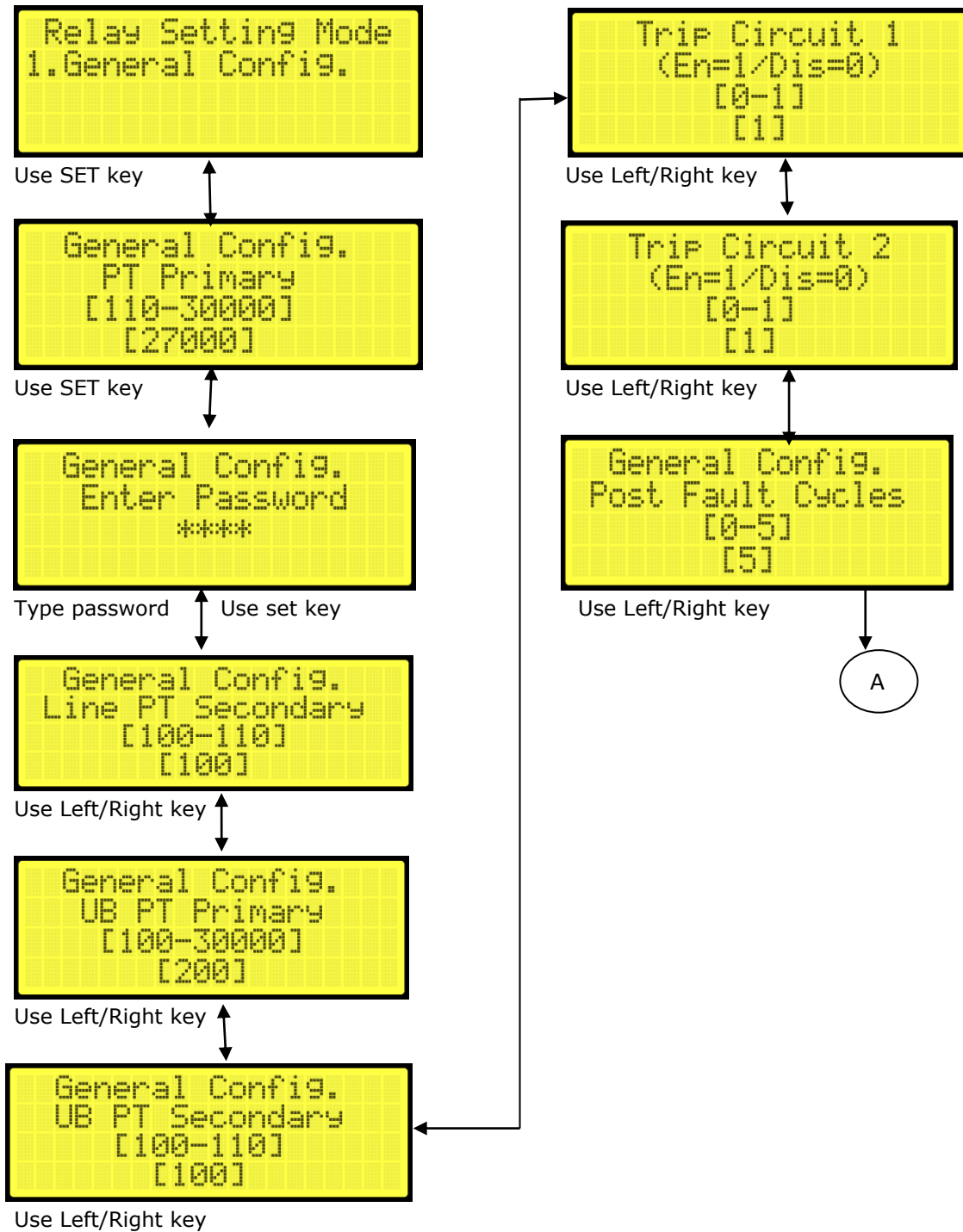

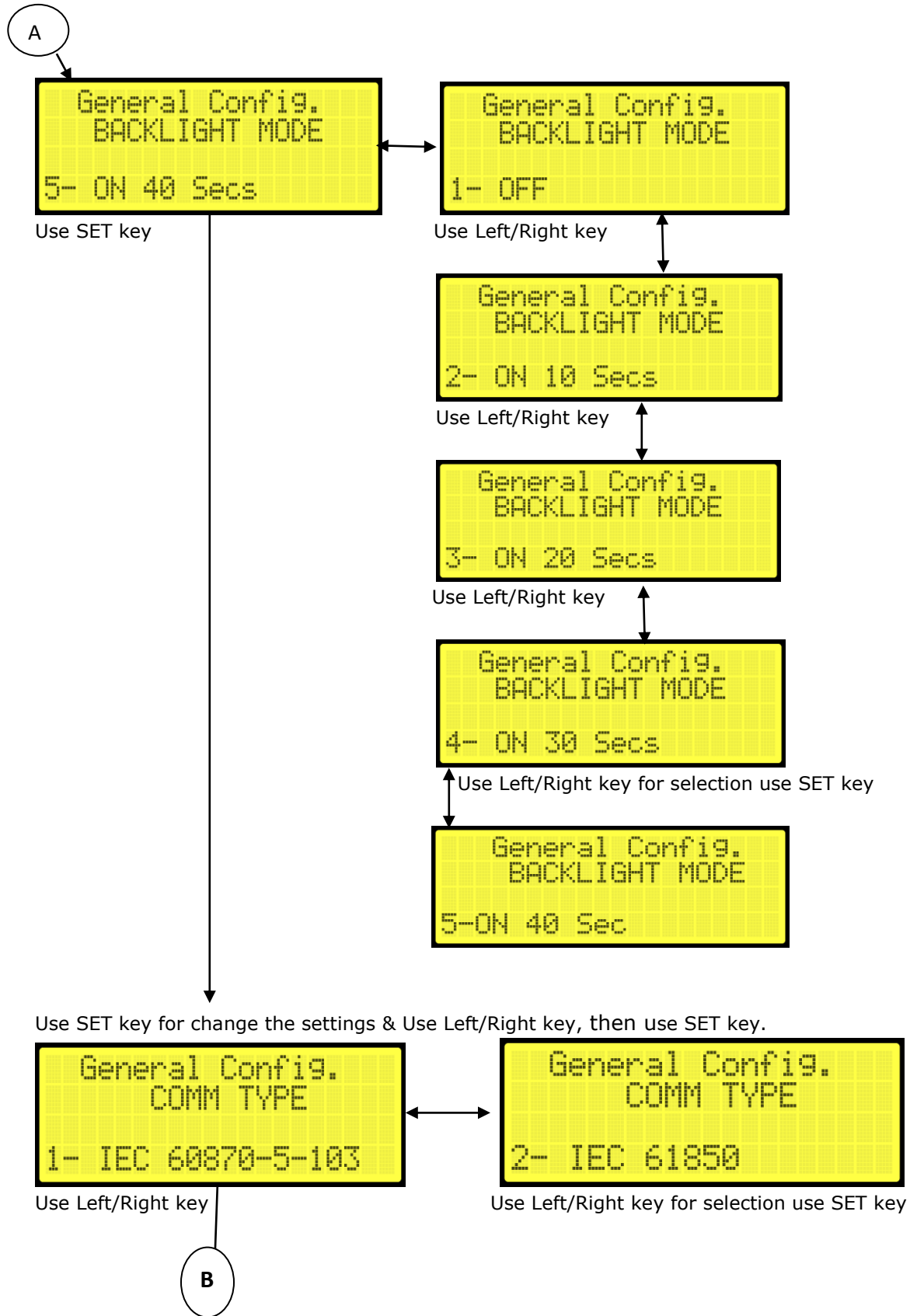



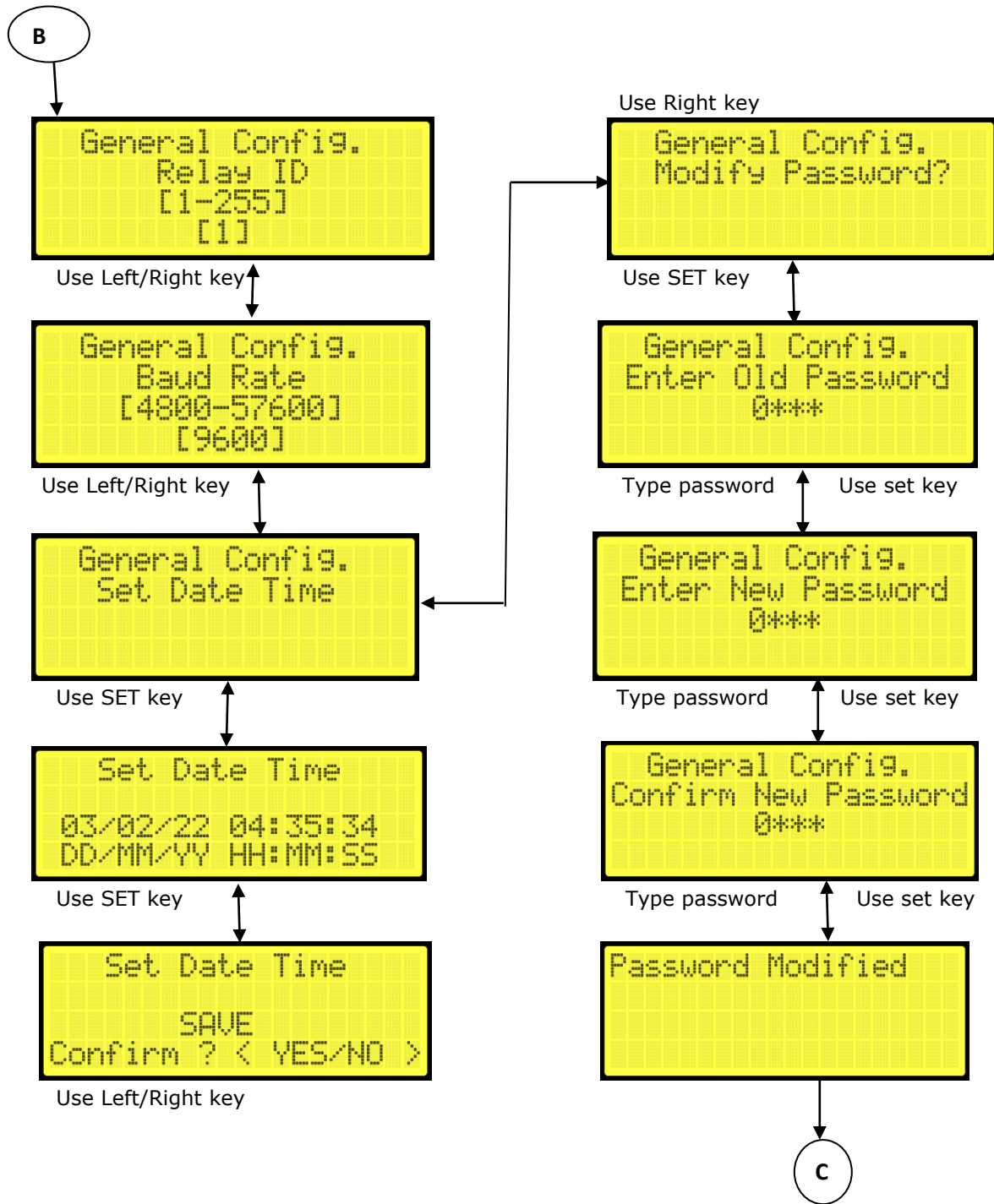

Use Left/Right key, for next window press both Left & Right keys simultaneously

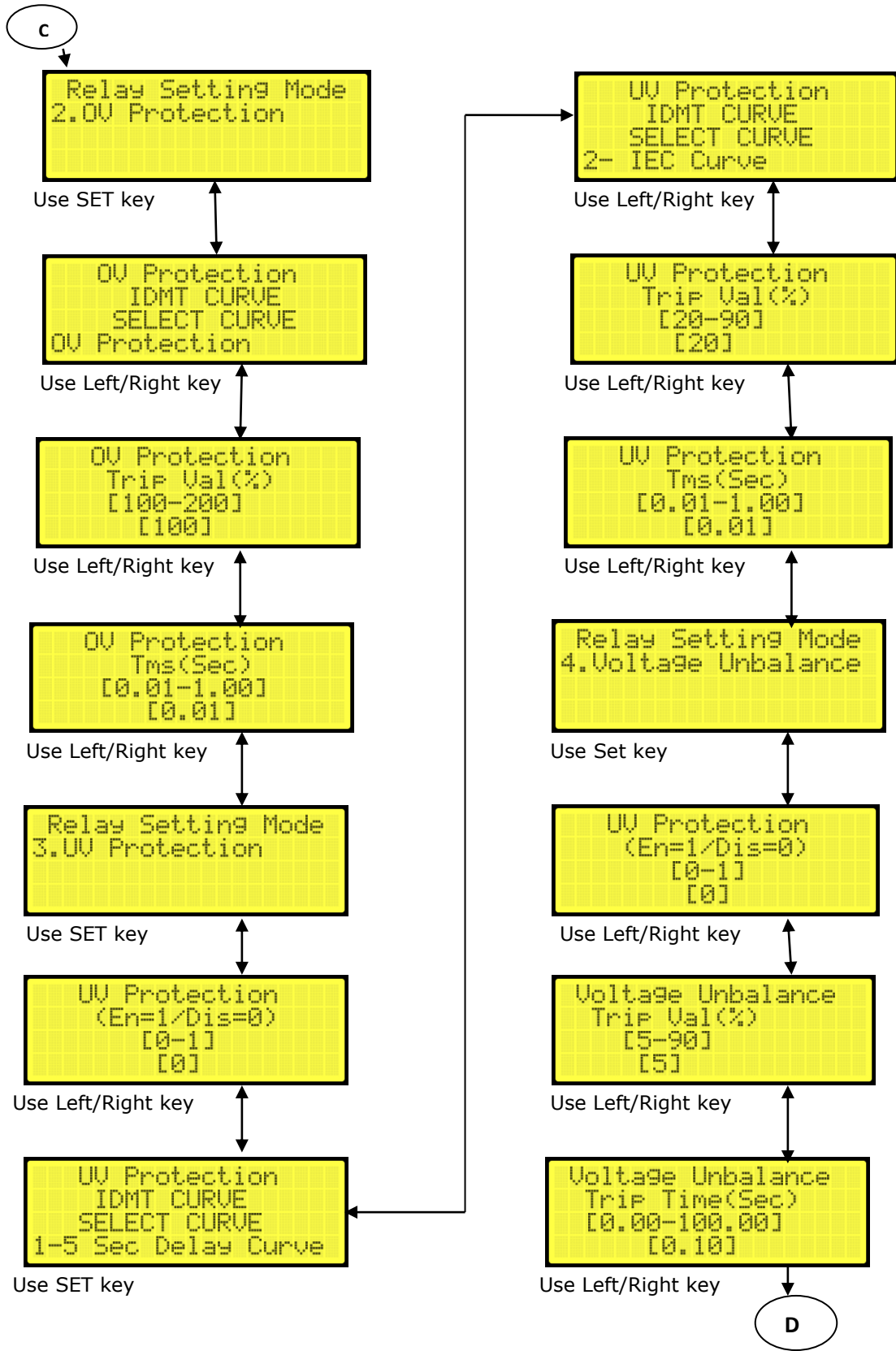

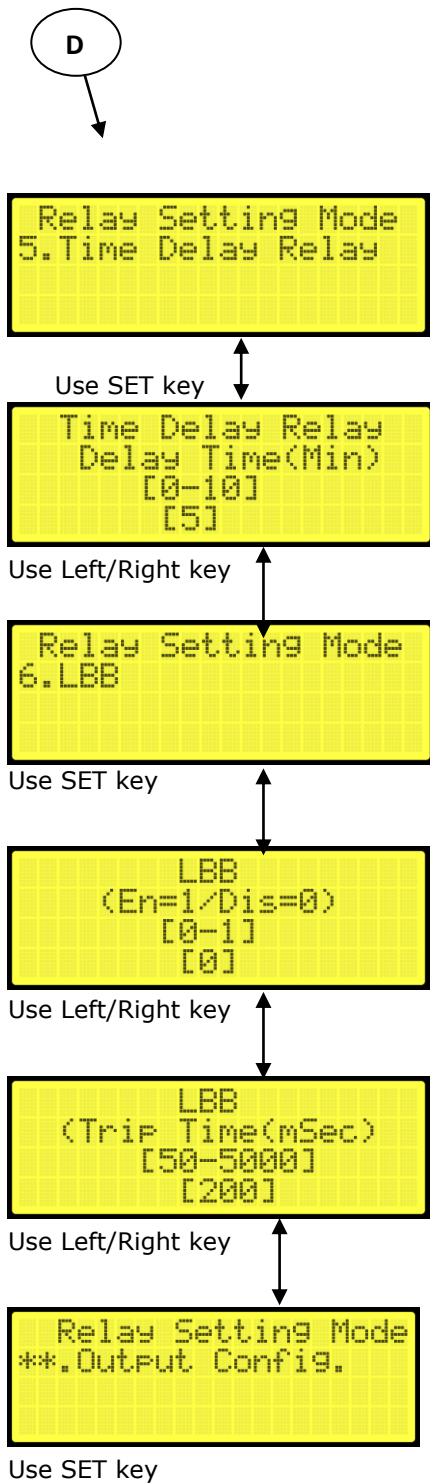

# To access & clear logs



Use this key

```
1.FAULT RECORDS
```

Use Set Key

```
FAULT RECORDS
FAULT ***
```

Use Set Key

```
*** UV Trip
U=**,.*U
Un1=**,.*U
DD/MM/YY HH:MM:SS
```

Use Right Key

```
*** UV Trip
Un2=**,.*U
Flt Clr Time=**,.*S
DD/MM/YY HH:MM:SS
```

Use Set Key

```
2.COUNTERS
```

Use Set Key

```
OU=***** UV=*****
UTGUB=*****
LBB=*****
```

Use Set Key

```
3.CLEAR RECORDS
```

Use Set Key

```
3.CLEAR RECORDS
Confirm ? <YES/NO>
```

Use Left/Right Key

```
3.CLEAR COUNTERS
```

Use Set Key

```
3.CLEAR COUNTERS
Confirm ? <YES/NO>
```

Use Set Key

```
4.EXIT
```

Use Set Key

### To view device Info.

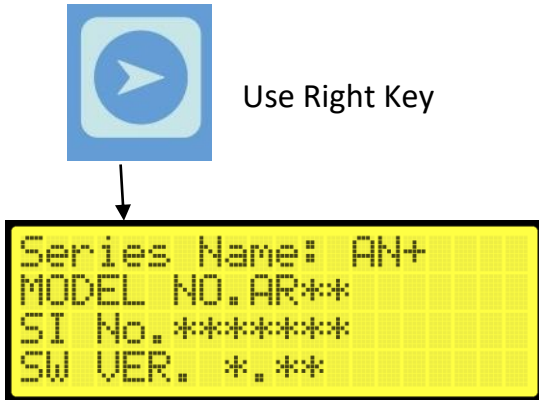

### For Relay healthiness check & I/O Verification

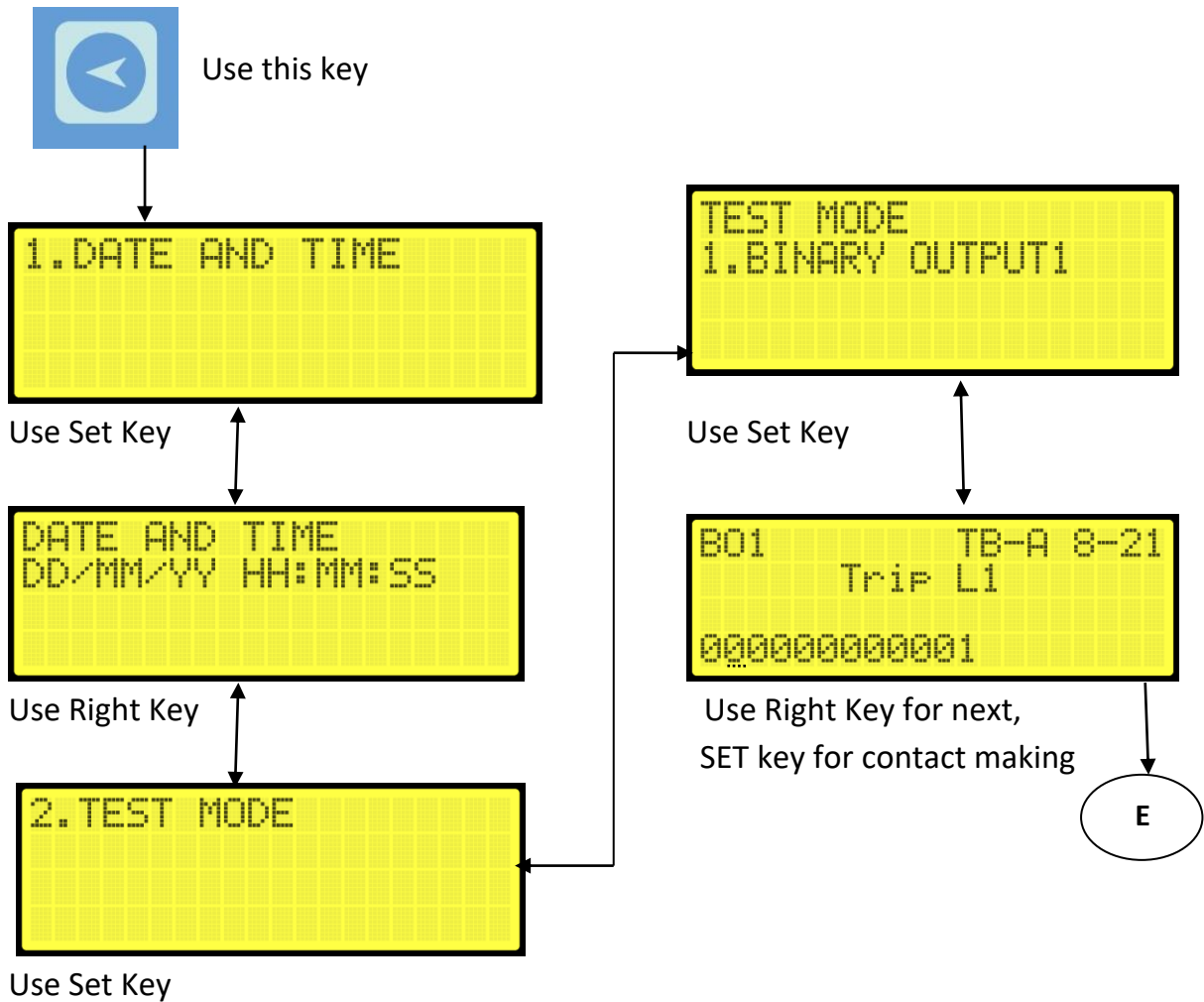

E

```
TEST MODE
2.BINARY OUTPUT2
```

Use Set Key

```
B02      TB-B2  ANN  2-4
                TEL  1-3
AP/GP Alarm
1000000000000
```

Use Right Key for next,  
SET key for contact making

```
TEST MODE
3.BINARY INPUT
```

Use Set Key

```
BI          TB-B1  24
AP/GP Alarm
1000000000000
```

Use Right Key for next move of cursor  
& corresponding name shows in display

```
TEST MODE
4.LED
```

Use Set Key

```
VISUALLY INSPECT
LED's
LED
```

Use Set Key

```
TEST MODE
5.SYSTEM INFO
```

Use Set Key

```
SYSTEM INFO:*****
*****
*****
*****
```

Use Set Key

```
4.EXIT
```

Use Set Key



## Binary Output & Input Details

Binary Output 1			Binary Outout 2			Binary Input		
BO1	NAME	TB NUMBER	BO2	NAME	TB NUMBER	BI	NAME	TB NUMBER
1	NIL		1	AP/GP Alarm	TB B2 - 1 & 3 , 2 & 4	1	AP/GP Alarm	TB B1 - 24
2	Trip L1	TB A - 8 & 21	2	AP/GP Trip & LOCK	TB B2 - 1 & 5 , 2 & 6	2	AP/GP Trip & LOCK	TB B1 - 21
3	Trip L2	TB A- 9 & 20	3	UV - L1	TB B2 - 1 & 7 , 2 & 8	3	UB Reset	TB B1 - 22
4	NIL		4	OV - L1	TB B2 - 1 & 9 , 2 & 10	4	CB Open	TB B1 - 19
5	NIL		5	V - UB1	TB B2 - 1 & 11 , 2 & 12	5	CB Close	TB B1 - 20
6	LBB 1	TB A- 12 & 17	6	V -UB2	TB B2 - 1 & 13 , 2 & 14	6	RCC Reset	TB B1 - 17
7	SPARE 1	TB A- 13 & 16	7	NIL		7	NIL	
8	SPARE 2	TB A- 14 & 15	8	TCS	TB B2 - 1 & 17 , 2 & 18	8	NIL	
9	Unbalance (NC)	TB B1 - 3 & 4	9	LBB	TB B2- 1 & 19 , 2 & 20	9	NIL	
10	TDR (NC)	TB B1 - 5 & 6	10	UV - L2	TB B2 - 1 & 21 , 2 & 22	10	NIL	
11	LBB 2	TB B1 - 7 & 8	11	OV - L2	TB B2 - 1 & 23 , 2 & 24	11	NIL	
12	Relay Error	TB B1 - 1 & 2	12	NIL		12	TCS 1	TB B1 - 11 & 12
						13	TCS 2	TB B1 - 9 & 10

### Binary Output 1

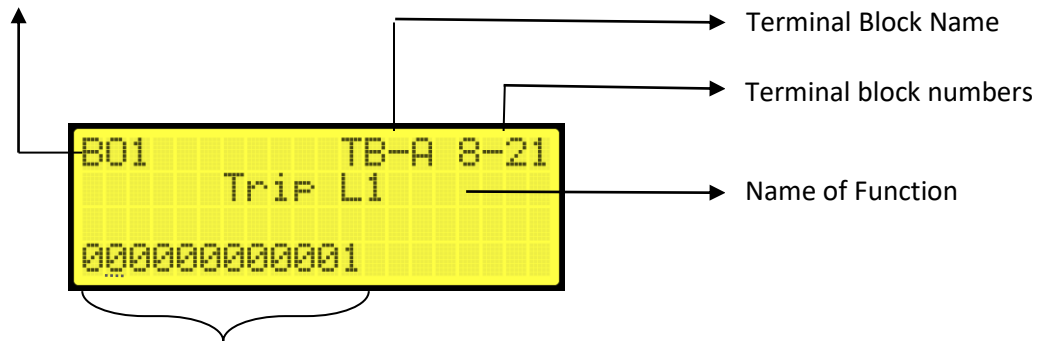

Binary Output Contacts. Use Left</>Right key for selecting previous or next contact & moving cursor also change the corresponding name in display. For make & reset contact use SET (↵) key.

### Binary Output 2

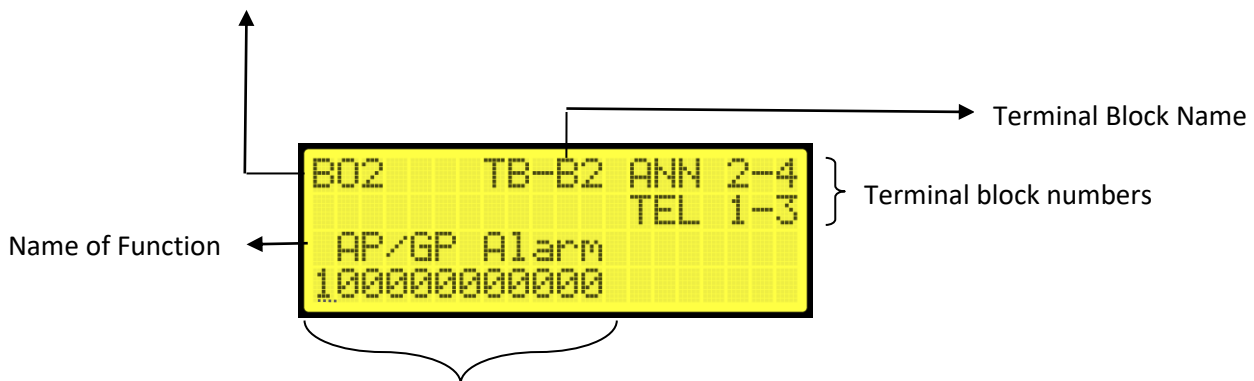

Binary Output Contacts. Use left</>Right key for selecting previous or next contact & moving cursor also change the corresponding name in display. For make & reset contact use SET (↵) key.

**NOTE:** TB B2 – 1 TELE COMMON (+110Vdc)  
TB B2 – 2 ANNU COMMON (+ve common from annunciator)



### Binary Input

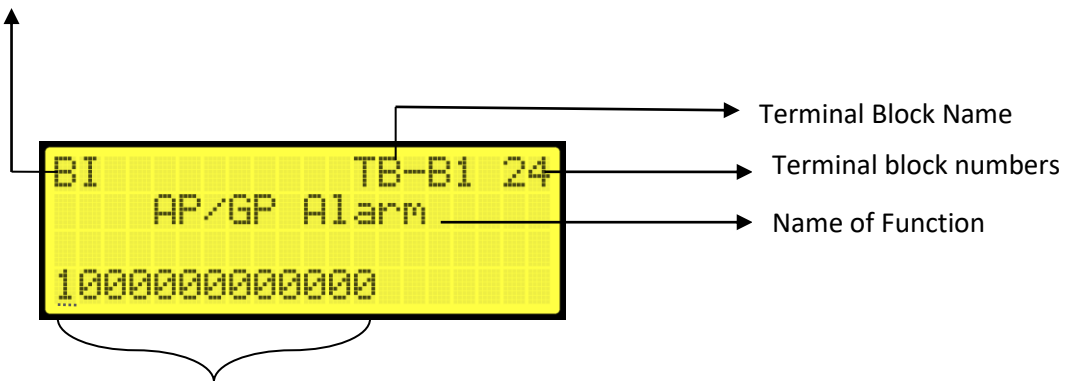

Use left/>Right key for selecting previous or next contact & moving cursor also change the corresponding name in display. When 110 DC (-ve) permanently supplied to the TB-B1-23 as status common and 110 DC (+ve) is given to the status pulse corresponding TB numbers in TB-B1.

# TECHNICAL DATA & CHARACTERISTIC CURVES

**CONTENTS**

DESCRIPTION OF PROTECTION FUNCTIONS

---

TECHNICAL SPECIFICATIONS

---

GENERAL SETTINGS

---

TB DETAILS

---

RELAY CONFORMING STANDARDS

---

## DESCRIPTION OF PROTECTION FUNCTIONS

AR39 relay is a comprehensive Voltage based Protection relay for the protection of **2x25 KV Capacitor bank Under/ over voltage and voltage unbalance protection**

### 1. Over voltage protection

The relay provides protection against over voltage with an over voltage element of inverse time characteristics. The over voltage relay is energized from the potential transformer connected to the main bus bar on the incoming side of the circuit breaker. The over voltage setting ranges from 100 to 200 % in steps of 1% and the time multiplier setting from 0.01 to 1.0 in steps of 0.01.

1. IEC 60255-127 curve

$$\text{Trip time} = \frac{T}{\frac{G}{G_s} - 1}$$

2. 7 sec delay curve

$$\text{Trip time } t = 1.23[T/\log(G/G_s)]$$

Where, T= TMS

G/G<sub>s</sub>=Injected Voltage/Set Voltage

### 2. Under voltage protection

An under voltage element with inverse time characteristics is provides protection against under voltage. The voltage setting ranges from 20 to 90% in steps of 1% and TMS from 0.01 to 1.0sec in steps of 0.01.

1. IEC 60255-127 curve

$$\text{Trip time} = \frac{T}{1 - (\frac{G}{G_s})}$$

2. 5 sec delay curve

$$\text{Trip time } t = T[1.68 + 1/\log(2-V)]$$

Where, T= TMS

G/G<sub>s</sub>=Injected Voltage/Set Voltage

### 3. Trip Circuit Supervision

Relay consists of two numbers of trip circuit supervisions (Post close and pre close). The relay continuously monitors the tripping coil DC (110V -ve) supply through the NC or NO contacts of the Circuit breaker in both open & closed condition. If any discontinuity is observed, the relay generates alarm signal.

**TECHNICAL SPECIFICATIONS**

Sl.No	Specification	REF.	Particulars
1.	<b>Auxiliary Supply</b>	V <sub>DC</sub>	35 to 260VDC
2.	<b>Voltage Input (rated)</b>	V	110V AC
3.	<b>Frequency</b>	F <sub>n</sub>	50 Hz
4.	<b>VA burden on Aux</b>		Less than 15 Watts (for energized condition) Less than 10 Watts (for de-energized condition)
5.	<b>VA burden on PT</b>		Less than 0.5 VA
6.	<b>Operating Temp Range</b>		-25°C to + 55 °C
7.	<b>Max. &amp; Minimum relative humidity</b>		5% to 95%
8.	<b>Contact details</b>		
9.	a)Current carrying capacity		Continuously ≥ 5 Amps at 110 V DC Short time ≥30 Amps for 200 ms at 110 V DC
	b) Making capacity at 110V DC		≥ 1000 W at L/R = 40ms
	c)Breaking Capacity at 110V DC		≥ 30 W at L/R = 40ms
10.	<b>Type of communication ports</b>		RJ45 (front) and RS485& RJ45 (Rear)
11.	<b>Overall dimensions</b>		
	Width		263 mm
	Height		173 mm
	Depth		300 mm
12.	<b>Weight</b>		5.6 kg approx.

**RELAY SETTINGS**

Settings	Particulars
<b>Password protection (YES/NO)</b>	<b>0000-9999</b>
<b>1. General configuration</b>	
Line PT Primary	110 to 30000V in steps of 10V
Unbalance PT Primary	110 to 30000V in steps of 10V
Trip Ckt Supervision 1	Enable/Disable
Trip Ckt Supervision 2	Enable/Disable
Post fault cycles	0-5 in steps of 1
Back light	0 – OFF 1 – 10S 2 – 20S 3 – 30S 4 – 40S

Communication type	1 – IEC 60870-5-103 2 – IEC 61850
Relay ID	1-255 in steps of 1
Baud Rate	4800-57600 in steps of 200
Set Date & Time	DD MM YYYY HH MM SS
Modify Password	
<b>2.OV Protection</b>	
IDMT characteristics	1 – 7 Sec delay 2 – IEC curve
Trip Val (%)	50 to 200% in steps of 1%
TMS	0.01-1.00 in steps of 0.01
<b>3. UV Protection</b>	
UV protection	EN/DIS
UV IDMT characteristics	1 – 5 Sec delay curve 2 – IEC curve
Trip Val (%)	20 to 90% in steps of 1%
TMS	0.01-1.00 in steps of 0.01
<b>4.Voltage Unbalance</b>	
Trip Val (%)	5 to 90% in steps of 1%
Trip Time (Sec)	0 to 100 Sec in steps of 0.1 sec
<b>5. Time Delay Relay</b>	
Delay Time (min)	0 to 10 min in steps of 1 min
<b>6. LBB</b>	
LBB 1	EN/DIS
LBB 2	EN/DIS
Trip Time (mSec)	0-5000 in steps of 1
<b>Operating Time</b>	
i) Over Voltage	Depends on TMS setting
ii) Under Voltage	Depends on TMS setting
iii) Unbalance Protection	Depends on time setting
v) LBB	Depends on Time setting

TB DETAILS

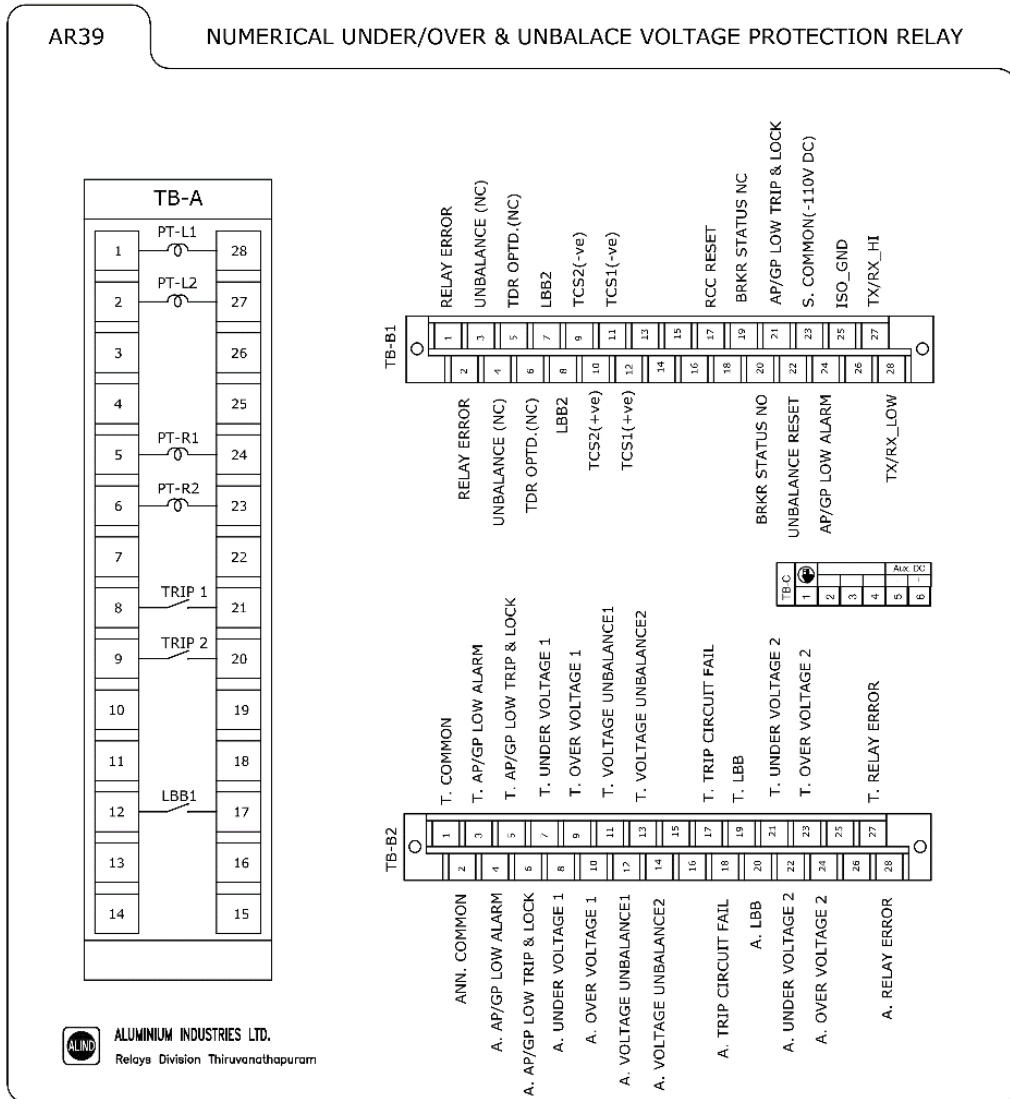

## RELAY CONFORMING STANDARDS

The relay conforms to the following standards:

SI No.	Standards	Description
I.	IEC 60255-151	FUNCTIONAL REQUIREMENTS FOR OVER/UNDER CURRENT PROTECTION.
II.	IEC 60255-5	INSULATION COORDINATION OF MEASURING RELAYS AND PROTECTION EQUIPMENT- REQUIREMENTS AND TESTS.
III.	IEC 60255-1	MEASURING RELAYS AND PROTECTION EQUIPMENT- COMMON REQUIREMENTS.
IV.	IEC 60255-21-1	VIBRATION TESTS (SINUSOIDAL)
V.	IEC 60255-21-2	SHOCK AND BUMP TESTS
VI.	IEC 60255-21-3	SEISMIC TESTS
VII.	IEC 60255-27	PRODUCT SAFETY REQUIREMENT.
VIII.	IEC 60255-26	ELECTROMAGNETIC COMPATIBILITY REQUIREMENT.
IX.	IEC 60529	DEGREES OF PROTECTION PROVIDED BY ENCLOSURES (IP CODE)
X.	IEC 61810-2	RELIABILITY.
XI.	IS 2705(PART II, III&IV)	PROTECTIVE CURRENT TRANSFORMERS.
XII.	IS 3231(PART 1 TO 3)	ELECTRICAL RELAYS FOR POWER SYSTEM PROTECTION.
XIII.	IS 8686	STATIC PROTECTIVE RELAYS.
XIV.	IEC 60068-2	ENVIRONMENTAL TESTS.
XV.	IEC 60870-5-103	COMMUNICATION PROTOCOL
XVI.	IEC 61850	COMMUNICATION PROTOCOL



# TROUBLESHOOTING

Under normal working conditions, the 'PROTECTION HEALTHY LED' provided in the front panel of the relay glows green. The same LED turns amber to recognize any fault inside the relay itself.

Following are certain guidelines for the relay to identify the nature of fault and necessary checking procedures to be adopted at site so that relay can be rectified suitably.

Sl. No.	Faults	Checks	Causes
1	No power ON Indication or No display.	1. Check the auxiliary DC supply to the relay rear terminals 2. Check the continuity of the output terminal, after disconnecting the wires.	1. Due to power supply failure, the LED turns off. 2. The varistor may short circuited to protect internal circuitry on transients
2	Current Not reading/ Out of tolerance limit.	1. Refer TB sticker for CT inputs. 2. Check for the earthing of CT. 3. Check if the terminals of TB-A is connected properly or for any lose contact. 4. Check CT ratio and multiplying factor if any. 5. Check the continuity of the output terminal, after disconnecting the wires. After checking of the above, measure the current using calibrated Clamp-On meter. If not OK, intimate to works.	1. The CT connector is having shorting facility. If the connector is not tight, CT secondary may get some low resistance path through the connector itself. 2. If CT is not properly earthed, there is a chance of leakage current that may cause error in CT reading.
4	Relay Error Indication	1. Intimate to works. 2. Press H.RST key in the relay front panel.	1. Supply variation to internal PCB's. 2. DC supply fail.

**SCADA COMMUNICATION INTERFACE AS PER IEC  
60870-5-103 PROTOCOL**

VERSION 1.00

**TYPE – AR 39**

**RELAY DESIGNED AS PER RDSO SPECIFICATION NO.  
TI/SPC/PSI/PROTCT/7101**



**ALUMINIUM INDUSTRIES LIMITED  
RELAYS DIVISION**

**PROTOCOL MAPPING****SYSTEM FUNCTIONS IN MONITOR DIRECTIONS**

DESCRIPTION	GI	ASDU TYPE	FUN	INF	COT	COM
End of general interrogation	-	8	255	0	10	GLB
Time synchronization	-	6	255	0	8	GLB
Reset FCB	-	5	181	2	3	According to main FUN
Reset CU	-	5	181	3	4	According to main FUN
Reset CU/Start/Restart	-	5	181	4	5	According to main FUN

**STATUS INDICATIONS IN MONITOR DIRECTION**

DESCRIPTION	GI	ASDU TYPE	FUN	INF	COT	COM
Protection Healthy/Active	-	1	181	18	1	↑↓
RCC Reset	-	1	181	19	1	↑
Local Parameter Settings (Change)	-	1	181	22	1	↑
AP/GP low alarm	X	1	181	29	1,9	↑↓
AP/GP trip & lock	X	1	181	30	1,9	↑↓
CB NC (FDR CB open)	X	1	181	136	1,9	↑↓
CB NO (FDR CB close)	X	1	181	137	1,9	↑↓
RCC Unbalance Reset	X	1	181	27	1,9	↑↓
TDR	X	1	181	31	1,9	↑↓
Relay Error	-	1	181	40	1	↑

**SUPERVISION INDICATIONS IN MONITOR DIRECTION**

DESCRIPTION	GI	ASDU TYPE	FUN	INF	COT	COM
Trip circuit supervision	X	1	181	36	1,9	↑↓

**FAULT INDICATION IN (MONITOR DIRECTIONS)**

DESCRIPTION	GI	ASDU TYPE	FUN	INF	COT	COM
Breaker Failure (LBB)	X	2	181	85	1,9	↑↓
Start/Pickup Over Voltage	X	2	181	95	1,9	↑↓
Start/Pickup Under Voltage	X	2	181	96	1,9	↑↓
Start/Pickup Unbalance Voltage – 1	X	2	181	98	1,9	↑↓
Start/Pickup Unbalance Voltage – 2	X	2	181	99	1,9	↑↓
Trip Under Voltage	-	2	181	116	1	↑↓

Trip Over Voltage	-	2	181	118	1	↑↓
Trip Unbalance Voltage – 1	-	2	181	165	1	↑↓
Trip Unbalance Voltage – 2	-	2	181	175	1	↑↓

### MEASURANDS IN MONITOR DIRECTION

DESCRIPTION	GI	ASDU TYPE	FUN	INF	COT
Measurand supervision V	-	9	181	148	2
Measurand supervision VUB1	-	9	181	149	2
Measurand supervision VUB2	-	9	181	150	2

### TIME TAGGED MEASURANDS IN MONITOR DIRECTIONS

DESCRIPTION	GI	ASDU TYPE	FUN	INF	COT
Fault Voltage – V	-	4	181	152	1
Fault Voltage – VUB1	-	4	181	153	1
Fault Voltage – VUB2	-	4	181	154	1

### STANDARD INFORMATION NUMBERS IN CONTROL DIRECTION

#### SYSTEM FUNCTIONS IN CONTROL DIRECTION

DESCRIPTION	GI	ASDU TYPE	FUN	INF	COT	COM
Initiation of general interrogation	-	7	255	0	9	GLB
Time Synchronization	-	6	255	0	8	GLB

#### GENERAL COMMANDS IN CONTROL DIRECTION

DESCRIPTION	GI	ASDU TYPE	FUN	INF	COT	COM
LED (RCC) RESET	-	20	181	19	20	↑ (PULSE)
CB Open	-	20	181	124	20	↑↓ (PULSE)
CB Close	-	20	181	125	20	↑↓ (PULSE)
Unbalance (RCC) Reset	-	20	181	35	20	↑ (PULSE)

**ANALOG CHANNEL INFORMATION IN AR 39**

AR 39		
FUN	ACC	PARAMETER
181	1	X
181	2	X
181	3	X
181	4	X
<b>181</b>	<b>5</b>	<b>V</b>
<b>181</b>	<b>6</b>	<b>VUB1</b>
<b>181</b>	<b>7</b>	<b>VUB2</b>
181	8	X

**DIGITAL CHANNEL (TAGS) INFORMATION IN AR 39**

AR 39			
TAG POSITION	FUN/INF NUMBER	SEMANTICS ACCORDING TO TAG POSITION	INPUT/OUTPUT
0	181/84	GENERAL PICKUP	OUTPUT
1	181/68	GENERAL TRIP	OUTPUT
2	181/118	OVER VOLTAGE TRIP	OUTPUT
3	181/116	UNDER VOLTAGE TRIP	OUTPUT
4	181/165	UNBALANCE VOLTAGE TRIP-1	OUTPUT
5	181/175	UNBALANCE VOLTAGE TRIP- 2	OUTPUT
6	181/85	LBB TRIP	OUTPUT
7	181/31	TDR (Time Delay Relay)	OUTPUT
8	181/27	UNBALANCE (RCC) RESET	INPUT
9	181/19	RCC RESET	INPUT
10	181/136	CB NC	INPUT
11	181/137	CB NO	INPUT
12	181/29	AP/GP LOW ALARM	INPUT
13	181/30	AP/GP LOW TRIP & LOCK	INPUT
14	181/36	TRIP CIRCUIT SUPERVISION	INPUT

Model Implementation Conformance Statement  
for the IEC 61850 interface in ALIND AR 39 relay version 1.0

Based on  
UCA International Users Group  
Testing Sub Committee

Template version 1.0  
Date: April 24, 2008

TITLE: MICS DOCUMENT FOR AR 39 RELAY	MICS Ver.	1.0
	DATE: 22 SEPTEMBER 2021	
	ALUMINIUM INDUSTRIES LTD   RELAYS DIVISION, THIRUVANANTHAPURAM	

# Index

	PAGE
INDEX.....	2
1. Introduction.....	3
2. Logical Device.....	4
3. Logical Node List.....	5
4. Logical Nodes.....	6
4.1 GGIO_CAP_4C.....	6
4.2 GGIO_CAP_ALM4.....	6
4.3 GGIO_CAP_BI7.....	6
4.4 LLN01 .....	7
4.5 LLN02 .....	7
4.6 LLN03 .....	7
4.7 LLN04 .....	8
4.8 LLN05 .....	8
4.9 LPHD_CAP .....	8
4.10 MMXN_CAP_MTR .....	9
4.11 MMXN_CAP_FLT .....	9
4.12 PTOV_CAP.....	9
4.13 PTUV_CAP.....	10
4.14 RBRF_CAP .....	10
4.15 RDRE_CAP.....	10
5. Enum types .....	11
5.1 Mod .....	11
5.2 ctlModel.....	11
5.3 Health.....	11





# 1. Introduction

This model implementation conformance statement is applicable for ALIND AR 39 relay. The definitions of all used Logical Devices, Logical Nodes and their associated Common Data Classes, components and associated enumerated values are also included for completeness.

This MICS document specifies the modelling compared to IEC 61850 Edition 2.

## 2. Logical Device

Logical Device	Description
CONTROL	Controls Domain
MEASUREMENT	Measurements Domain
PROTECTION	Protection Domain
RECORDS	Fault Records Domain
SYSTEM	System Domain

### Logical Device data model

Logical Device	Logical Node Instance	Logical Node type	Description
CONTROL	LLN0	LLN01	LLN0 for Logical Device CONTROL
	CNTRL_GGIO1	GGIO_CAP_4C	IED output 4 contacts
MEASUREMENT	LLN0	LLN02	LLN0 for Logical Device MEASURAND
	MTR_MMXN1	MMXN_CAP_MTR	Measurand V, VUB1, VUB2
	FLT_V_MMXN2	MMXN_CAP_FLT	Fault Voltage V, VUB1, VUB2
PROTECTION	LLN0	LLN03	LLN0 for Logical Device PROTECTION
	OV_PTOV1	PTOV_CAP	Over Voltage Protection
	VOL_UB1_PTOV1	PTOV_CAP	Unbalance Voltage Protection 1
	VOL_UB2_PTOV2	PTOV_CAP	Unbalance Voltage Protection 2
	UV_PTUV1	PTUV_CAP	Under Voltage Protection
	LBB_RBRF1	RBRF_CAP	Breaker Failure
RECORDS	LLN0	LLN04	LLN0 for Logical Device RECORDS
	RDRE1	RDRE_CAP	Disturbance recorder
SYSTEM	LLN0	LLN05	LLN0 for Logical Device SYSTEM
	LPHD	LPHD_CAP	Physical Device Information
	ALM_GGIO1	GGIO_CAP_ALM4	Alarms
	IND_GGIO2	GGIO_CAP_BI7	Binary Inputs

# 3. Logical Node List

Following list contains list of logical node classes implemented in device

<b>G: Logical Nodes for generic references</b>	
GGIO (Generic Process I/O)	
<b>L: System Logical Nodes</b>	
LLNO (Logical device LN)	
LPHD (Physical device LN)	
<b>M: Logical Nodes for metering and measurement</b>	
MMXN (Non-Phase Related Measurement)	
<b>P: Logical Nodes for protection functions</b>	
PTOV (Over Voltage)	
PTUV (Under Voltage)	
<b>R: Logical nodes for protection related functions</b>	
RBRF (Breaker Failure)	
RDRE (Disturbance Recorder Function)	

# 4. Logical Nodes

The following table use

- M: Data object is mandatory in the IEC 61850-7-4 ED.2.
- O: Data object is optional in the IEC 61850-7-4 ED.2 and is used in the device
- E: Data object is extension to the IEC 61850-7-4 ED.2 and is used in the device

## 4.1 Logical Node: GGIO\_CAP\_4C

**Description:** Generic Process I/O

**LN Class:** GGIO

Data Object	CDC type	Description	M/O
<b>Common Logical Node Information</b>			
Beh	ENS	Behavior	M
<b>Controls</b>			
SPCSO1	SPC	Generic single point controllable status output (RCC Reset)	O
SPCSO2	SPC	Generic single point controllable status output (CB Open Command)	O
SPCSO3	SPC	Generic single point controllable status output (CB Close Command)	O
SPCSO4	SPC	Generic single point controllable status output (Unbalance Reset)	O

## 4.2 Logical Node: GGIO\_CAP\_ALM4

**Description:** Generic Process I/O

**LN Class:** GGIO

Data Object	CDC type	Description	M/O
<b>Common Logical Node Information</b>			
Beh	ENS	Behavior	M
<b>Status Information</b>			
Alm1	SPS	General Single Alarm (Protection Healthy/Active)	O
Alm2	SPS	General Single Alarm (Local Parameter Setting change)	O
Alm3	SPS	General Single Alarm (Time Delay Relay)	O
Alm4	SPS	General Single Alarm (Relay Error)	O

## 4.3 Logical Node: GGIO\_CAP\_BI7

**Description:** Generic Process I/O

**LN Class:** GGIO

Data Object	CDC type	Description	M/O
<b>Common Logical Node Information</b>			
Beh	ENS	Behavior	M
<b>Status Information</b>			
Ind1	SPS	General Indication (RCC Reset)	O
Ind2	SPS	General Indication (AP/GP low alarm)	O

Ind3	SPS	General Indication (AP/GP trip & lock)	O
Ind4	SPS	General Indication (CB NC status)	O
Ind5	SPS	General Indication (CB NO status)	O
Ind6	SPS	General Indication (RCC Unbalance reset)	O
Ind7	SPS	General Indication (Trip Circuit Supervision)	O

#### 4.4 Logical Node: LLN01

**Description:** Logical Node Zero

**LN Class:** LLN0

Data Object	CDC type	Description	M/O
<b>Common Logical Node Information</b>			
Beh	ENS	Behavior	M
Mod	ENC	Mode	M
Health	ENS	Health	M
NamPlt	LPL	Name Plate	M

#### 4.5 Logical Node: LLN02

**Description:** Logical Node Zero

**LN Class:** LLN0

Data Object	CDC type	Description	M/O
<b>Common Logical Node Information</b>			
Beh	ENS	Behavior	M
Mod	ENC	Mode	M
Health	ENS	Health	M
NamPlt	LPL	Name Plate	M

#### 4.6 Logical Node: LLN03

**Description:** Logical Node Zero

**LN Class:** LLN0

Data Object	CDC type	Description	M/O
<b>Common Logical Node Information</b>			
Beh	ENS	Behavior	M
Mod	ENC	Mode	M
Health	ENS	Health	M
NamPlt	LPL	Name Plate	M

#### 4.7 Logical Node: LLN04

**Description:** Logical Node Zero

**LN Class:** LLN0

Data Object	CDC type	Description	M/O
<b>Common Logical Node Information</b>			
Beh	ENS	Behavior	M
Mod	ENC	Mode	M
Health	ENS	Health	M
NamPlt	LPL	Name Plate	M

#### 4.8 Logical Node: LLN05

**Description:** Logical Node Zero

**LN Class:** LLN0

Data Object	CDC type	Description	M/O
<b>Common Logical Node Information</b>			
Beh	ENS	Behavior	M
Mod	ENC	Mode	M
Health	ENS	Health	M
NamPlt	LPL	Name Plate	M

#### 4.9 Logical Node: LPHD\_CAP

**Description:** Physical Device Information

**LN Class:** LPHD

Data Object	CDC type	Description	M/O
<b>Descriptions</b>			
PhyNam	DPL	Device Name Plate	M
<b>Status Information</b>			
PhyHealth	ENC	Device Health	M
Proxy	ENS	Indicates if this Logical Node is Proxy	M

#### 4.10 Logical Node: MMXN\_CAP\_MTR

**Description:** Non-Phase Related Measurements (Metering Voltages)

**LN Class:** MMXN

Data Object	CDC type	Description	M/O/E
<b>Common Logical Node Information</b>			
Beh	ENS	Behavior	M
<b>Measured and Metered Values</b>			
Vol1	MV	Measurand Voltage (V)	E
Vol2	MV	Measurand Voltage (Unbalance Voltage VUB1)	E
Vol3	MV	Measurand Voltage (Unbalance Voltage VUB2)	E

#### 4.11 Logical Node: MMXN\_CAP\_FLT

**Description:** Non-Phase Related Measurements (Fault Voltages)

**LN Class:** MMXN

Data Object	CDC type	Description	M/O/E
<b>Common Logical Node Information</b>			
Beh	ENS	Behavior	M
<b>Measured and Metered Values</b>			
Vol1	MV	Fault Voltage (V)	E
Vol2	MV	Fault Voltage (Unbalance Voltage VUB1)	E
Vol3	MV	Fault Voltage (Unbalance Voltage VUB2)	E

#### 4.12 Logical Node: PTOV\_CAP

**Description:** Over Voltage Protection

**LN Class:** PTOV

Data Object	CDC type	Description	M/O
<b>Common Logical Node Information</b>			
Beh	ENS	Behavior	M
<b>Status Information</b>			
Str	ACD	Start	M
Op	ACT	Operate	O

#### 4.13 Logical Node: PTUV\_CAP

**Description:** Under Voltage Protection

**LN Class:** PTUV

Data Object	CDC type	Description	M/O
<b>Common Logical Node Information</b>			
Beh	ENS	Behavior	M
<b>Status Information</b>			
Str	ACD	Start	M
Op	ACT	Operate	M

#### 4.14 Logical Node: RBRF\_CAP

**Description:** Breaker Failure

**LN Class:** RBRF

Data Object	CDC type	Description	M/O
<b>Common Logical Node Information</b>			
Beh	ENS	Behavior	M
<b>Status Information</b>			
OpEx	ACT	Breaker Failure External Trip	M

#### 4.15 Logical Node: RDRE\_CAP

**Description:** Disturbance Recorder Function

**LN Class:** RDRE

Data Object	CDC type	Description	M/O
<b>Common Logical Node Information</b>			
Beh	ENS	Behavior	M
<b>Status Information</b>			
RcdMade	SPS	TRUE = disturbance recording complete	M
FltNum	INS	Fault Number	M



# 5. Enum types

Enum types are listed in this clause.

## 5.1 Mod

Value	Description
1	on
2	blocked
3	test
4	test/blocked
5	off

## 5.2 ctlModel

Value	Description
0	status-only
1	direct-with-normal-security
2	sbo-with-normal-security
3	direct-with-enhanced-security
4	sbo-with-enhanced-security

## 5.3 Health

Value	Description
1	Ok
2	Warning
3	Alarm



## **ALUMINIUM INDUSTRIES LTD**

**Relays division, Kavinpuram, Vilappilsala (P.O)  
Thiruvananthapuram, Kerala, India-695 573**

**☎: 0471-2379704, 2379503**

**🌐: [www.alindrelays.com](http://www.alindrelays.com)**

**✉: [contact@alindrelays.com](mailto:contact@alindrelays.com) (enquiry)**

**✉: [service@alindrelays.com](mailto:service@alindrelays.com) (service)**