

# NUMERICAL OC + EF/REF PROTECTION RELAY - AR56 [AN+ SERIES]



# USER MANUAL



**ALUMINIUM INDUSTRIES LIMITED  
RELAYS DIVISION, THIRUVANANTHAPURAM**

# AR56

## Numerical OC + EF/REF Protection Relay

### CONTENTS

SAFETY REQUIREMENTS	AR56-I
INTRODUCTION	AR56-II
HANDLING INSTALLATIONS & CASE DIMENSIONS	AR56-III
USER GUIDE	AR56 -IV
TECHNICAL DATA & CHARACTERISTIC CURVES	AR56-V
TROUBLE SHOOTING	AR56-VI
COMMUNICATION	AR56-VII

# **SAFETY REQUIREMENTS**

## CONTENTS

INTRODUCTION

---

HEALTH AND SAFETY

---

SYMBOLS AND EXTERNAL LABELS ON THE RELAY

---

INSTALLING, COMMISSIONING AND SERVICING

---

DECOMMISSIONING AND DISPOSAL

---

TECHNICAL SPECIFICATION FOR SAFETY

---

## INTRODUCTION

Before using this product, be sure to read this chapter carefully.

This chapter describes safety precautions when using the relay. Before installing and using the equipment, read and understand this chapter thoroughly.

It's not a secret – electricity can be dangerous and when things go wrong lives can be at stake!

Electrical engineers are Industrial safety doctors, so it's our duty to keep employees health and maintain a quality of life that we all deserve by providing safe work practices to avoid electrical accidents.

### How much electricity is dangerous?????

CURRENT	EFFECT
0.5 – 3mA	Tingling sensations
3 – 10mA	Muscle contractions (painful)
10 – 40mA	"can't let go" phenomena
40 – 75mA	Respiratory paralysis (possibly fatal)
75 – 200mA	Ventricular fibrillation (likely fatal)
200 – 500mA	Heart clamps tight
>1.5A	Tissue and organs began to burn

**Fact: A 15 amp circuit breaker was designed to protect equipment – not people!**

The relay is developed with zero percentage of risk factor by its own design. The current carrying paths and circuits are isolated from the metal case and structure. Suitable clearance depending on the type of insulation required for different classes are provided.

The relay confirms to Product safety requirement standard IEC 60255-27:2013

## HEALTH AND SAFETY

It deals with the handling of relay in proper way. An individual to be considered as 'qualified' with regard to certain equipment in the workplace, but 'unqualified' as to other equipment. "An employee, who is undergoing on the job training and who, in the course of such training, has demonstrated the ability to perform duties safely at his or her level of training and who is under the direct supervision of a qualified person also considered to be a qualified person for the performance of those duties."

The following requirements must be met, in the order given, before circuits or equipments are re-energized, even temporarily.

- People handling the equipment should be aware about the relay safety handlet.
- Ensure that the product is in the off condition before working on the conducting or terminal side.
- A qualified person must conduct tests and visual inspections, as necessary, to verify that tools electrical jumpers, shorts, grounds and other such devices have been removed, so that the circuits and equipments can be safely re-energized.
- Employees exposed to the hazards associated with re-energizing the circuit or equipment must be warned to stay clear of the circuits and equipment.
- Each lock and tag must be removed by the employee who applied it or someone else under that employee's direct supervision.
- A visual determination that all employees are clear of the circuits and equipments must be made.

For any queries related to relays, feel free to contact ALIND.

**SYMBOLS AND LABELS USED IN THE RELAY**

1. FRONT SIDE



Caution: refer to equipment documentation



Caution: risk of electric shock



Caution: Over voltage Cat.III

2. REAR SIDE



**WARNING**

- 1. No user serviceable components inside.
- 2. Refer servicing to authorized personnel.



Protective Conductor (\*Earth) terminal  
Functional/Protective Conductor (\*Earth) terminal.



CMOS Battery provided for the RTC (Real Time Clock) purpose. Confirm polarity of the battery while replacing.



IEC 61850 sticker

**WARNING****Current transformer circuit**

Never allow the current transformer (CT) secondary circuit connected to this equipment to be opened while the primary system is live. Opening the CT circuit will produce a dangerous high voltage.

**Exposed terminals**

Do not touch the terminals of this equipment while the power is on, as the high voltage generated is dangerous.

**Residual voltage**

Hazardous voltage can be present in the DC circuit just after switching off the DC power supply. It takes about 30 seconds for the voltage to discharge.

**CAUTION****Earth**

Earth the earthing terminal of the equipment securely.

**Operation conditions**

Use the equipment within the range of ambient temperature, humidity and dust as detailed in the specification and in an environment free of abnormal vibration.

**Ratings**

Before applying AC voltage and current or DC power supply to the equipment, check that they conform to the equipment ratings.

**Printed circuit board**

Do not attach and remove the printed circuit board while the DC power to the equipment is on, as this may cause the equipment to malfunction.

**External circuit**

When connecting the output contacts of the equipment to an external circuit, carefully check the supply voltage used and prevent the connected circuit from overheating.

**Connection cable**

Carefully handle the connection cable without applying excessive force.





### Modification

Do not modify this equipment, as this may cause the equipment to malfunction, and in such cases, warranty may be affected.

## DECOMMISSIONING AND DISPOSAL



### De-commissioning

The supply input (auxiliary) for the equipment may include capacitors across the supply or to earth. To avoid electric shock or energy hazards, after completely isolating the supplies to the equipment, the capacitors should be safely discharged via the external terminals prior to de-commissioning.



### Disposal

When disposing of this equipment, do so in a safe manner according to local regulations. It is recommended that incineration and disposal to water courses is avoided. Ensure the relay is in de energized condition and take precautions to avoid short circuits.

## TECHNICAL SPECIFICATIONS FOR SAFETY

### 1. Protective class

IEC 60255-27:2013

Class I (This equipment requires a protective conductor (earth) connection to ensure user safety.)

### 2. Environment

IEC 60255-27:2013

Pollution degree 2 (Normally only non-conductive pollution occurs except occasionally a temporary conductivity caused by condensation is to be expected.)

### 3. Overvoltage Category

IEC 60255-27:2013

Category III (The auxiliary energizing circuits of the equipment are connected to a common battery, common mode transient voltages of a relatively high value may appear on the supply leads, and differential mode voltages may arise from switching in other circuits connected to the same battery source.)

### 4. Contact data

Test voltage across open contact: 1 kV DC for 1 min

# INTRODUCTION

## CONTENTS

AN SERIES DESCRIPTION

---

PREVIOUS HISTORY OF FEEDER PROTECTION RELAYS

---

BRIEF DESCRIPTION OF AR56

---

MAIN FUNCTIONS

---

GENERAL FUNCTIONS

---

**AN+ SERIES (ALIND NUMERICAL SERIES)**

- ❖ Advanced Digital Fourier Transform based Numerical algorithm design using 32-bit Digital Signal Controller.
- ❖ Compact Construction covering several protection modules viz Over Current Protection, Earth Fault/ Restricted Earth Fault protection along with Trip Circuit supervision in single module thus saving panel space.
- ❖ Display of protection acted, fault current, fault clearing time, fault date & time of latest 200 faults at Relay LCD.
- ❖ Man-Machine Communication through 20x4 character LCD display.
- ❖ Self-supervision of both hardware and software units.
- ❖ Interface ability with SCADA through IEC 60870-5-103 & IEC 61850 communication protocol
- ❖ Facility for storing fault waveforms (Disturbance recorder) and events with date and time stamping. At a time, a total of 5000 events and 200 latest fault waveform (Disturbance recorder) will be stored in the relay.
- ❖ Graphical User Interface for Harmonic analysis, DC analysis and di/dt analysis can be done on the uploaded fault waveforms with facility for report generation.
- ❖ Facility to access/modify the relay settings both online as well as through menu in local PC
- ❖ Relay Indication (LED) reset from RCC
- ❖ IP 54 grade enclosure protection.
- ❖ SNTP (Simple Network Time Protocol) & optional GPS based IRIG -B time code standard Synchronization Facility.
- ❖ Online HV current & LV current display on relay LCD.
- ❖ Settable CT ratios.
- ❖ Relay operation Counter

## PREVIOUS HISTORY OF OC AND EF PROTECTION RELAYS

### **TMAS 101a.**

*Static Type.*

*First product in Traction Transformer Protection.*

### **ATP 214 (AN Series)**

*Numerical Integrated Transformer protection relay*

*Miniaturized Transformer protection module.*

***Built in counter facility.***

***Plug in type modular construction.***

*Disturbance & event recorder.*

*SCADA Interface (IEC 60870-5-103 Compatible).*

*Compact Design.*

### **ANTP 202/302/402 (AN Series)**

*Numerical Integrated Transformer protection relay*

*Miniaturized Transformer protection module.*

*Disturbance & event recorder and detailed fault analyzer.*

*Cable less hardware design*

*SCADA Interface (Full-fledged IEC 60870-5-103 protocol).*

*Compact Design.*

Designed as per RDSO specification no. TI/SPC/PSI/PROTCT/7101 and 6072.

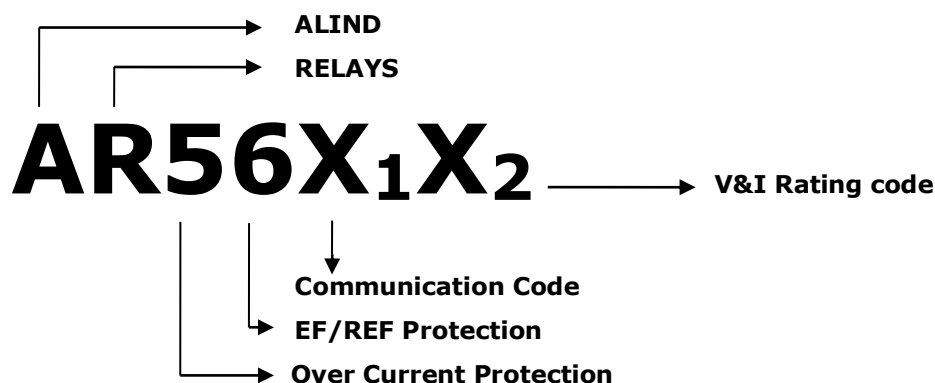

Protection naming codes	
0.	None
1.	Panto Flash Over Protection
2.	Distance Protection
3.	Under/Over Voltage Protection
4.	Current Unbalance Protection
5.	Over Current Protection
6.	EF/REF Protection
7.	Delta I Protection
8.	Current Differential Protection
9.	Voltage Unbalance Protection

Communication naming codes- X <sub>1</sub>	
A	IEC 60870-5-103
B	IEC 60870-5-103 + IEC61850 (RJ45)
C	IEC 60870-5-103 + IEC61850 (LC)
D	IEC 60870-5-103 + IEC61850 (Redundant RJ45)
E	IEC 60870-5-103 + IEC61850 (Redundant LC)
F	IEC 60870-5-103 + IEC61850 (Redundant RJ45) + IRIG B
G	IEC 60870-5-103 + IEC61850 (Redundant LC) + IRIG B
H	IEC 60870-5-103 + IRIG B
I	IEC 60870-5-103 + IEC61850 (RJ45) + IRIG B
J	IEC 60870-5-103 + IEC61850 (LC) + IRIG B

V & I Rating codes-X <sub>2</sub>	
1	1A CT
2	110V AC& 1A
3	110V AC& 5A
4	230V AC& 110V DC
5	5A CT
6	100AC& 1A
7	100AC& 5A
8	100AC
9	110V AC

**PROTECTION FEATURES**

**AR56** conforms to RDSO specification no. TI/SPC/PSI/PROTCT/7101 and TI/SPC/PSI/PROTCT/6072. AR56 (AN+ Series) relay is a Three OC and one EF/REF protection relay using in 25KV and 2X25KV AC Traction substations.

**MAIN FUNCTIONS**

SI No.	PARTICULARS	HV SIDE	LV SIDE
<b>1.</b>	<b>MAIN PROTECTIONS</b>		
1.1	IDMT OCR	✓	✓
1.2	Instantaneous OCR	✓	-
1.3	Definite Time OCR	✓	✓
1.4	Earth Fault	✓	✓
1.5	Post Over Load	✓	✓
1.6	LBB	✓	✓
1.7	RELAY ERROR	✓	✓
<b>2.</b>	<b>STATUS INPUTS</b>		
2.1	Trip Circuit Supervision	✓	✓
2.2	AP/GP Low Alarm	✓	✓
2.3	AP/GP Low Trip & Lock	✓	✓
2.4	Buchholz Alarm	✓	-
2.5	Winding Temperature Alarm	-	✓
2.6	Oil Temperature Alarm	✓	-
2.7	Low Oil Level Alarm	-	✓
2.8	RCC Reset	✓	✓
2.9	Circuit Breaker Status (NO/NC)	✓	✓

**GENERAL FUNCTIONS**

SI No.	PARTICULARS	AR56
1.	<b>Password protection</b>	✓
2.	<b>Event Memory</b>	5000
3.	<b>Disturbance recorder waveforms</b>	200
4.	<b>50 cycles (45 pre and 5 post fault) of fault waveform for I</b>	✓
5.	<b>Communication</b>	
5.1	GUI Interface	RJ45
5.2	Isolated RS485 & RJ45/ LC Fiber Interface	✓
5.3	Communication Protocol Interface- IEC 60870-5-103 & IEC 61850	✓
5.4	GPS Time Synchronization Facility through IRIG-B	✓
5.5	Date/time synchronization through PC	✓
6.	<b>Monitoring</b>	
6.1	Current	✓
6.2	Selectable CT ratio:5-5000/5A	✓
6.3	Counters for each element	✓
7.	<b>Other features</b>	
7.1	Test facility in Relay setting Mode(offline)	✓
7.2	Compact Module	✓
7.3	Plug In Type	✓

# **HANDLING INSTALLATIONS & CASE DIMENSIONS**



## CONTENTS

HANDLING OF RELAY

---

STORAGE

---

RELAY AND RACK MOUNTING

---

CASE DIMENSIONS

---

## **HANDLING OF RELAY**

Protective relays generally of robust construction require careful treatment prior to installation on site. Care must be taken when unpacking and installing the relays so that none of the parts are damaged. Relays must be handled by skilled personnel. The following should be taken into account while handling the relay:

- ✦ The relay use components that are sensitive to electrostatic discharges. The relay comprises of various semi-conductor devices which can damage if touched by means of direct contact. Handle the cards in static free environment since electrostatic discharge can affect performance of the relay or cause damage to the cards.
- ✦ The electronic circuits are well protected by the metal case and the internal module should not be withdrawn unnecessarily.
- ✦ The relay is normally shipped in separately packed condition. After unpacking, see if there is any mechanical damage to the cabinet, the nameplate, terminal blocks etc. Damage of any such sort identified shall be intimated to works.
- ✦ Avoid plugging in/ pulling out the cards when the power is ON.
- ✦ Do not apply CT inputs when auxiliary supply is switched OFF.
- ✦ If the cards are withdrawn for testing, ensure proper positioning while replacing.
- ✦ Keep the relays in well-packed condition in a dust-free dry environment without direct exposure to sunlight.

The relay is shipped from factory after detailed testing by our Quality Control Department. However, according to the customer requirement the relay settings/ functions can be verified before commissioning at respective sites with proper testing kits.

## **STORAGE**

If relays are not to be installed immediately upon receipt, they should be stored in a place free from dust and moisture in their original boxes. At most care should be taken while storage.

Storage temperature: -25°C to +55°C.

**RELAY AND RACK MOUNTING**

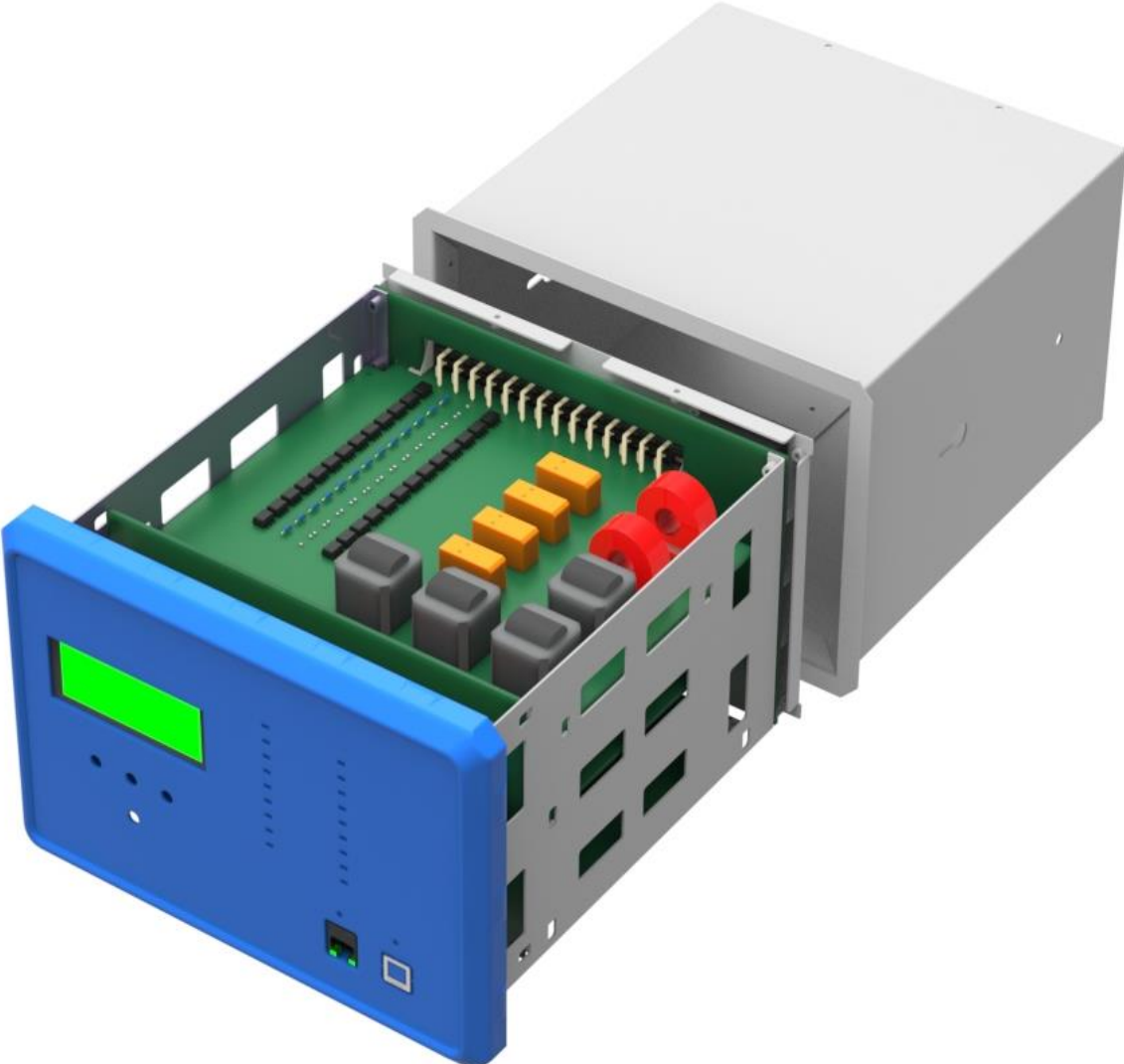

**CASE DIMENSIONS**

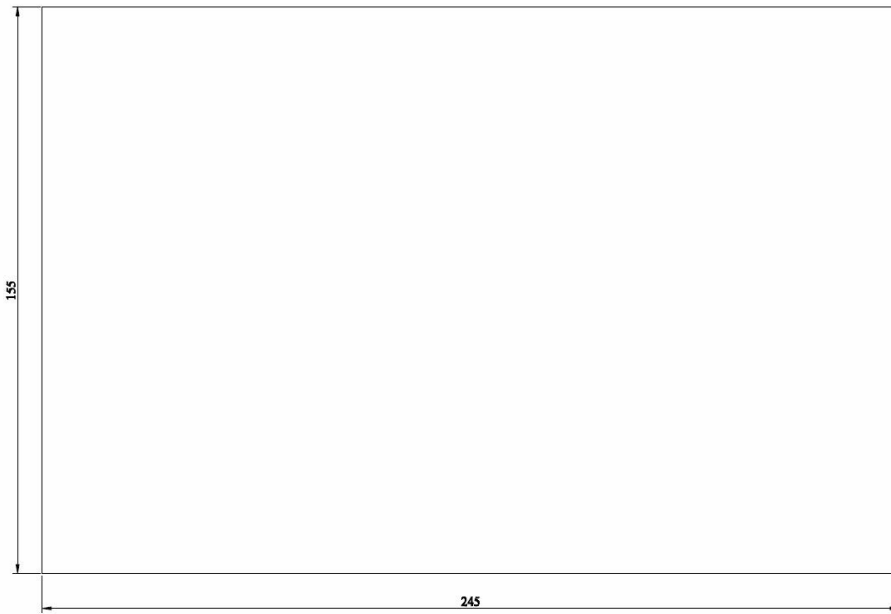
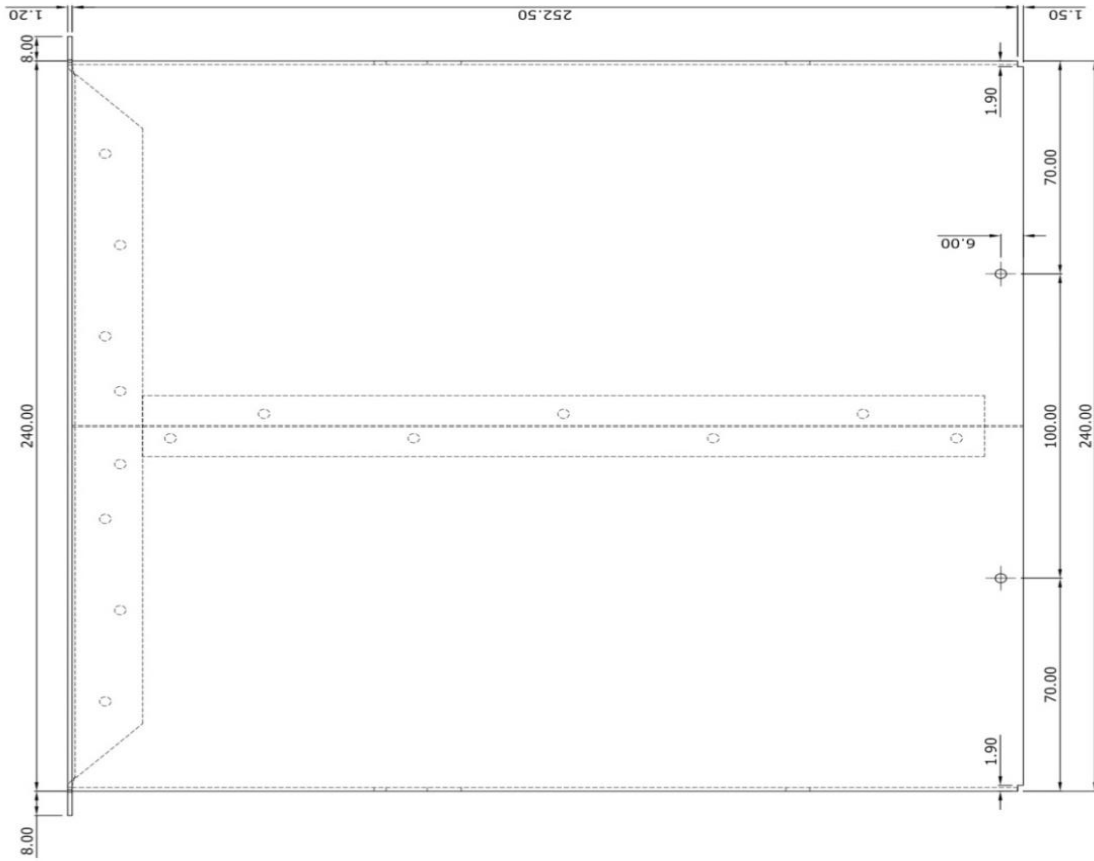

CUT OUT DETAILS

# USER GUIDE

## CONTENTS

FRONT PANEL INDICATIONS

---

INTERNAL ARCHITECTURE AND BLOCK DIAGRAM

---

ENERGIZING THE RELAY

---

PCB DESCRIPTION

---

RELAY ONLINE DISPLAY PARAMETERS

---

### FRONT PANEL INDICATIONS

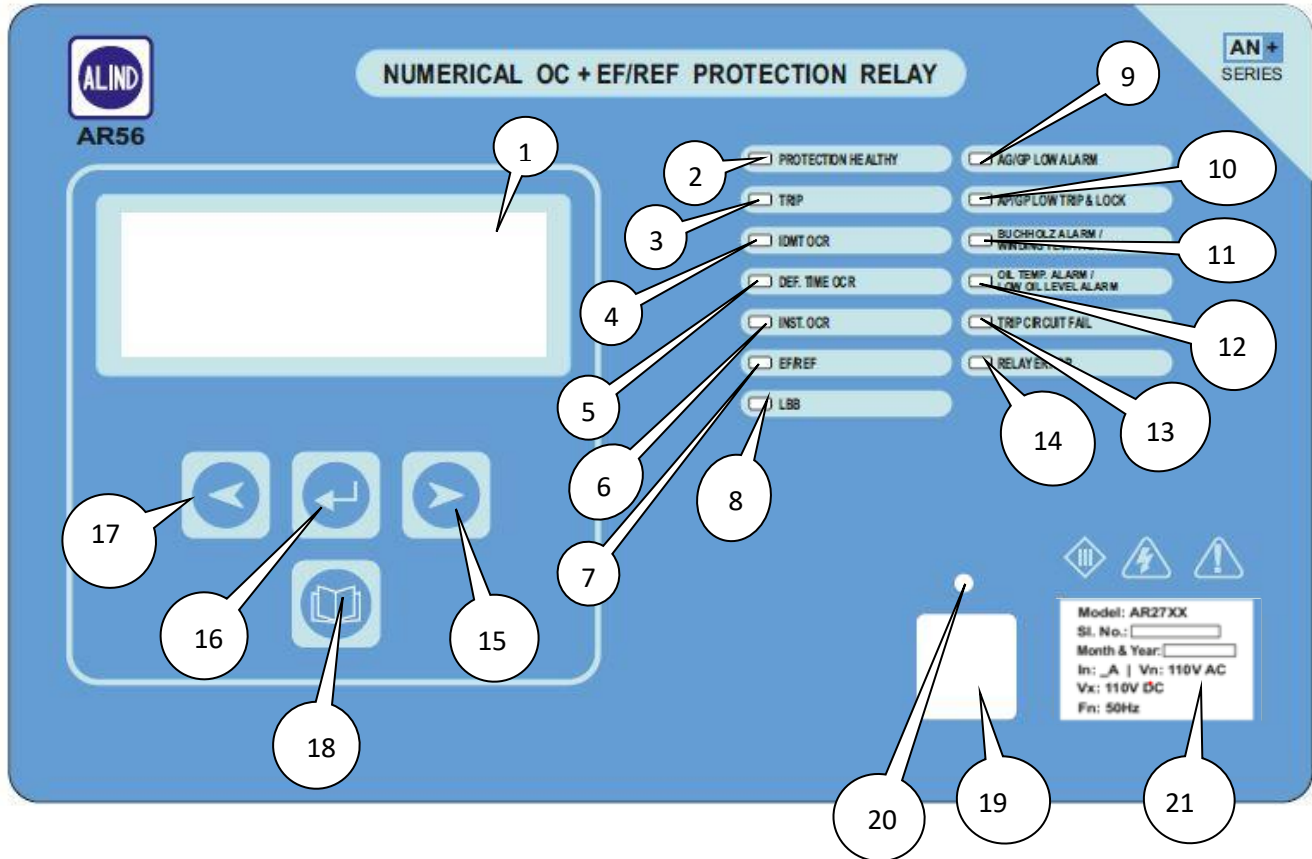

No	Legend
1.	LCD DISPLAY
2.	PROTECTION HEALTHY (Green/Amber)
3.	TRIP (Red)
4.	IDMT OCR TRIP (Red)
5.	DEFINIT TIME OCR TRIP (Red)
6.	INST.OCR TRIP (Red)
7.	EF/REF TRIP (Red)
8.	LBB OPERATED (Red)
9.	AP/GP LOW ALARM (Red)
10.	AP/GP LOW TRIP & LOCK (Red)
11.	BUCHHOLZ ALARM/WINDING TEMP. ALARM (Red)
12.	OIL TEMP.ALARM/LOW OIL LEVEL ALARM (Red)
13.	TRIP CIRCUIT FAIL (Red)
14.	RELAY ERROR (Red)
15.	>
16.	↵
17.	<
18.	Records
19.	RJ45 PORT
20.	H.RST
21.	Name plate



## LCD DISPLAY

A 20 x 4 LCD display is provided for easy viewing of parameters, relay settings, fault event records, date& time, error counter etc. The display backlit can be made ON by pressing any push button key and the display backlit ON time is settable.

## Navigation Keys

The relay is provided with four switches.

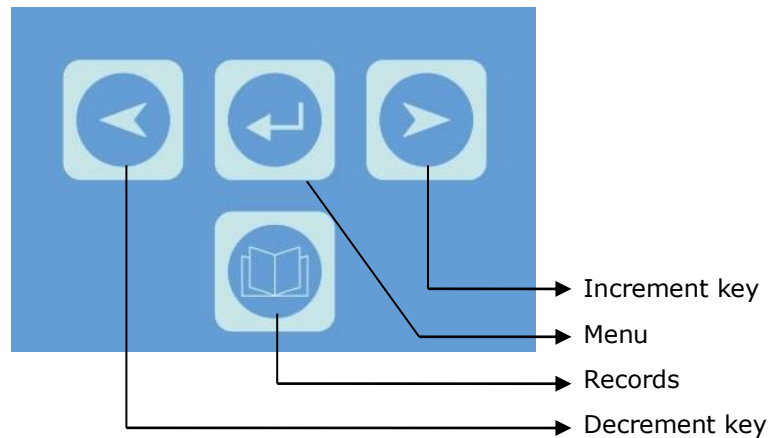

### Menu key

- \* Main key for entering relay setting mode.
- \* If you want to select anything in the setting mode, we can use this key.
- \* To reset the relay from tripping mode.

### Increment key

- \* If you want to raise any particular setting, we can use this option.
- \* For saving any particular changes in the relay, you can use this key.
- \* For viewing new options in the relay, we can use this key.

### Decrement key

- \* If you want to lower any particular setting, we can use this option.
- \* No need to save any unwanted mistakes in the relay you can use this key.
- \* If you want to verify any previous settings in the relay, you can use this key.

### Records key

- \* If you want to check the logs and data stored in the relay memory, you can use this key.

## INTERNAL SYSTEM LEVEL ARCHITECTURE

The internal system level architecture of relay including card to card architecture in brief is shown below.

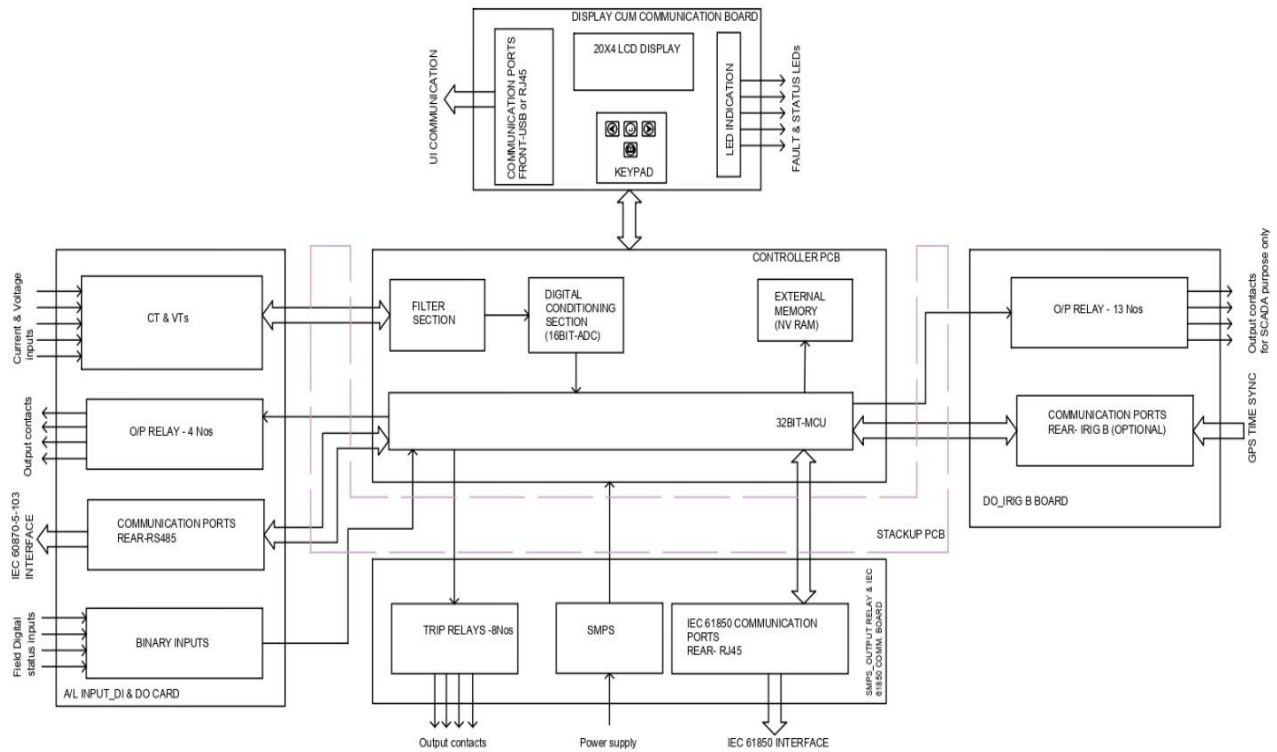

### 1. DSP Controller

The 32bit MCU (Digital Signal Controller) machine that combines the control advantages of a high-performance 32-bit microcontroller with the high computation speed of a fully implemented Digital Signal Processor (DSP).

The MCU controller continuously monitors the currents. Based on this the controller performs different calculations and whenever an abnormal condition occurs it distinguishes the type of fault and issues trip command to the circuit breaker.

### 2. Data Acquisition

The Current signals are scaled and isolated using Current Transformer (CT). These isolated analog signals are filtered to minimize the effects of electromagnetic interference and noise in the high frequency range.

The analog signals are then fed to the Analog to Digital Converter which has a 16 bit resolution. The DSP controller will take the 32 samples per cycles of Current for the computational purpose. If any fault occurs the parameters will be stored in to the non-volatile memory with date and time stampings and this can be downloaded for further analysis in the disturbance recorder.

### 3. Power Supply Module

This module gives the necessary regulated voltages like +5V, -5V, and +24V to various cards in the module. The normal operating voltage range is 45 VDC to 170 VDC. The +24V is used for driving the output relays in the I/O card and O/P relay card. The +5V and -5V is supplied to the processor, I/O card and Display PCB for normal relay operations. The isolated +5V is dedicated to the communication ports of the relay.

## 4. Communication Module

The relay is having three communications port, Front port: RJ45, Rear port: ETHERNET & RS485. The relay is using IEC 60870-5-103 & IEC 61850-communication protocol for communication through RS485 & ETHERNET.

### Front Port:

#### 1) Communication Port

RJ 45 port shall be provided for uploading/downloading relay settings and events.

### Rear Port:

#### a) RS 485 Communication Port

RS 485 port shall be provided for SCADA connectivity. Using RS485 port fault online data of critical parameters, disturbance record, and event record (Trip data) etc shall be downloaded. The communication protocol shall comply to IEC 60870-5-103 protocol.

#### b) Ethernet Communication Port

Ethernet port shall be provided for IEC 61850 connectivity. Using Ethernet port fault online data of critical parameters, disturbance record, event record (Trip data) etc. shall be downloaded. SNTP time synchronization is possible through the same. Ethernet port can either be copper/fiber depending upon the tender requirement.

## 5. Man Machine Interface

Man Machine Interface is through a 20x4 LCD display and keys in the front panel of the relay. Necessary LEDs are provided in front panel for indicating the operation of different element.

## 6. Disturbance Recorder

The relay has the facility to record 50 cycles (45 pre-fault and 5 post faults) of fault waveforms. Latest 200 waveforms of Current can be stored in the relay. This data is retrievable through front and rear communication ports using UI software and SCADA respectively.

## 7. Event Recorder & Disturbance Recorder

The relay is capable of storing 5000 number of events with date and time stamping of 1ms accuracy. The event data comprise of:

Tripping of different protection elements (I, Fault clearing time, Fault date & time)

Trip circuit supervision

Relay pick up

Relay reset

CB Trip

CB Close

Change of status input

Relay setting changed (GUI & Keypad)

Relay Error.

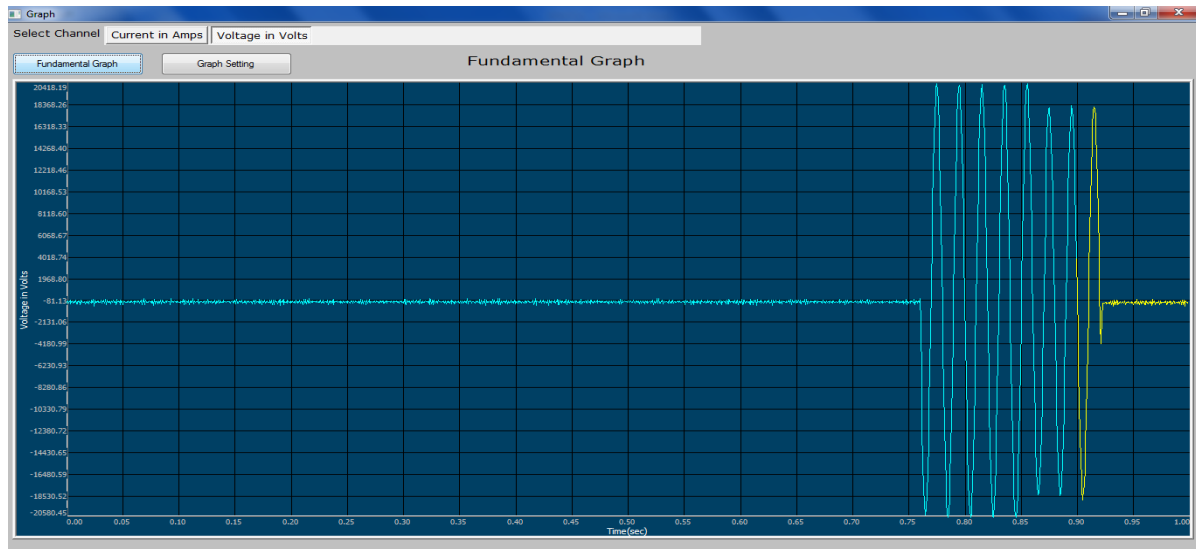

## ENERGIZING THE RELAY

1. Before turning ON the relay, proper earthing should be provided.
2. Visual Inspection for any physical damage in housing, display etc. shall be checked.
3. Operating voltage range: **45 to 170 VDC**. Rated Operating voltage: **110 V DC**.
4. Prefer regulated power supply of 110VDC.
5. Auxiliary power supply shall be provided to the corresponding terminals with the help of an MCB.
6. Switch on the power supply. Measure the voltage between the corresponding terminals and ensure that the voltage is within the normal operating range.
7. After the relay is powered ON, the following shall be noticed.

Protection healthy LED glow green in color which indicates that the relay is functioning OK, otherwise it goes amber.

## PCB DESCRIPTION

The relay comprises of the following hardware.

**Main PCBs.** –Display PCB, Controller PCB, Stack PCB, status & CT, PT PCB, SMPS & trip relay PCB, Tele Annu PCB, Back panel PCB

**Display cum Communication PCB (640 261):** The Display PCB is mounted at the front plate of the unit. It consists of the 20x4 LCD, LED indications, Keyboard circuits, LED controller and front RJ 45 communication port.

**Controller PCB (640 262):** The Controller PCB is mount on the backside of the Display PCB. This PCB consists of major components such as DSP controllers, ADC and its filter circuits, Memory ICs, RTC etc. The Analog signal get filtered and digitized in this board. The DSP takes decision based on this digital samples and initiates necessary commands.

**Stack PCB (640 263):** Internal communications between the PCB's are ensured with the help of stack PCB.

**Status & CT,PT PCB (640 264):** All the CTs, PTs and Input status lines are assembled in this board. IEC 60870-5-103 communication port also provided in this PCB.

**SMPS & Trip Relay PCB (640 265):** The SMPS PCB provides the necessary Power supply voltages to the different PCBs mounted inside the relay. The SMPS provides +24V, +5V, -5V and isolated +5 V. The +24 V supply is used for the driving the output relays. The +5V and -5V is supplied to the controller PCB, Display PCB, and I/O PCB for normal operations. The isolated +5V is dedicated to the communications ports of the relay.

This board (trip relay PCB) will give necessary trip commands to the master trip relay or breaker, which is installed in the yard. Necessary relay initiating signals are wired to these output relays from the Controller Board.

**Tele Annu PCB (640 266):** All the Telesignalling output circuits are assembled in this PCB. IRIG B circuit also provided in this PCB.

**Back Panel PCB (640 267):** This PCB consists of terminal blocks for external interface with the site and power connectors, which connects SMPS, I/O and CT PT PCB's. The RS 485 port is also mounted in this PCB. The terminal block (TB-A) is having CT shorting facility. Since the rack with Terminal Blocks is having the CT shorting facility, the relay can be withdrawn.

## RELAY ONLINE DISPLAY PARAMETERS

After Power ON, the relay boot screen shows

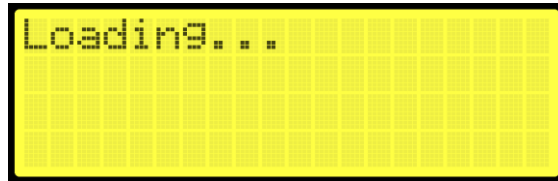

Then comes the online parameter display

Window:

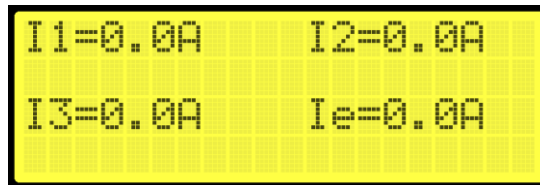

### Setting Mode

Press and hold **↵** for 5 seconds

Relay will enter to setting mode.

Enter the password and press **↵** key. The default password setting is '1000'

To change settings:

- Press **↵** to change the settings.
- Press **Right** key to increment
- Press **Left** key to decrement
- Press **↵** to accept change.
- To coming back to main **MENU** while operating, press **Left** and **Right** key simultaneously.
- Repeat the process for all settings
- After completing the settings, the relay shows the message '**SETTINGS UPDATED**' and returns to the operating mode.

### Relay Settings Algorithm

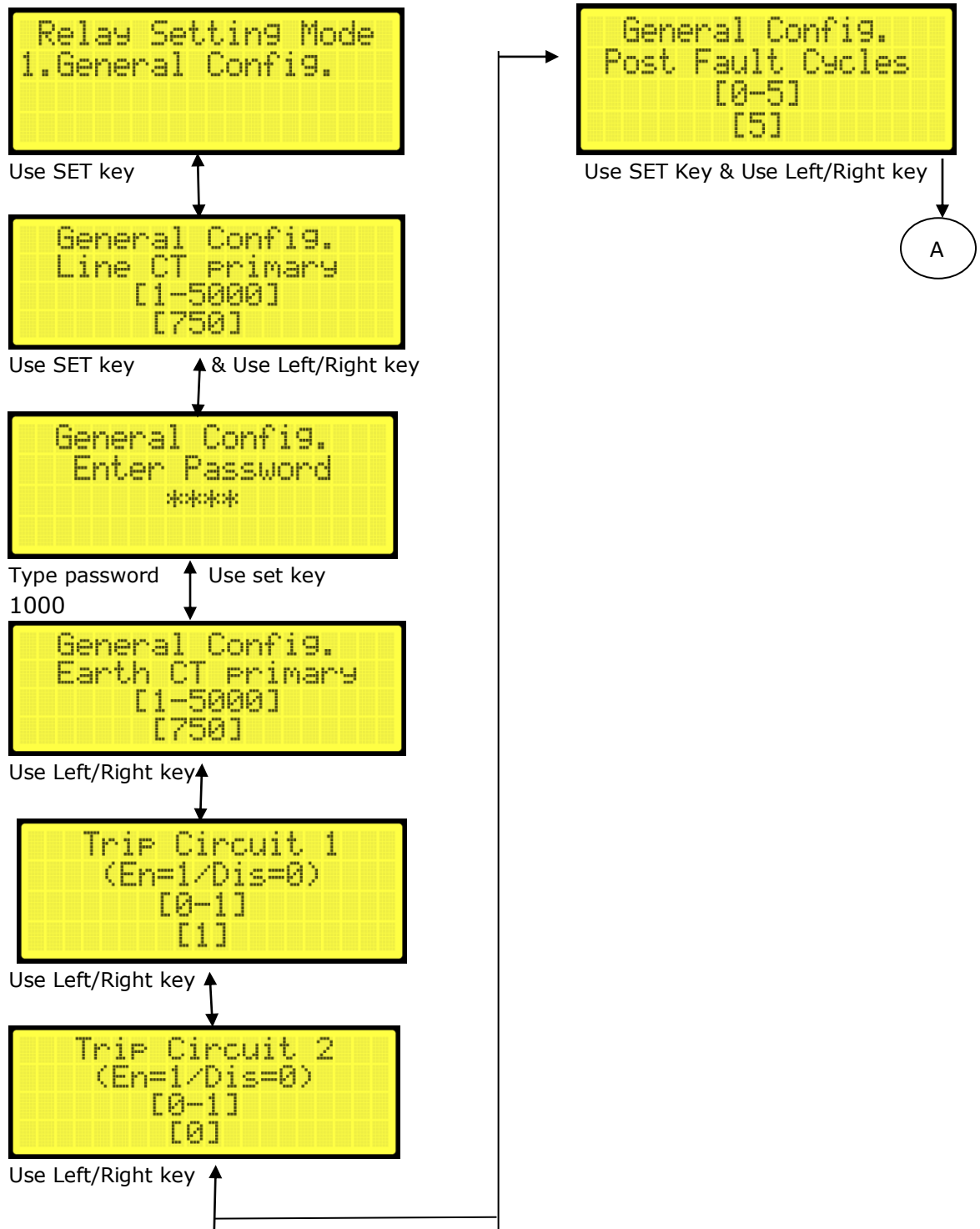

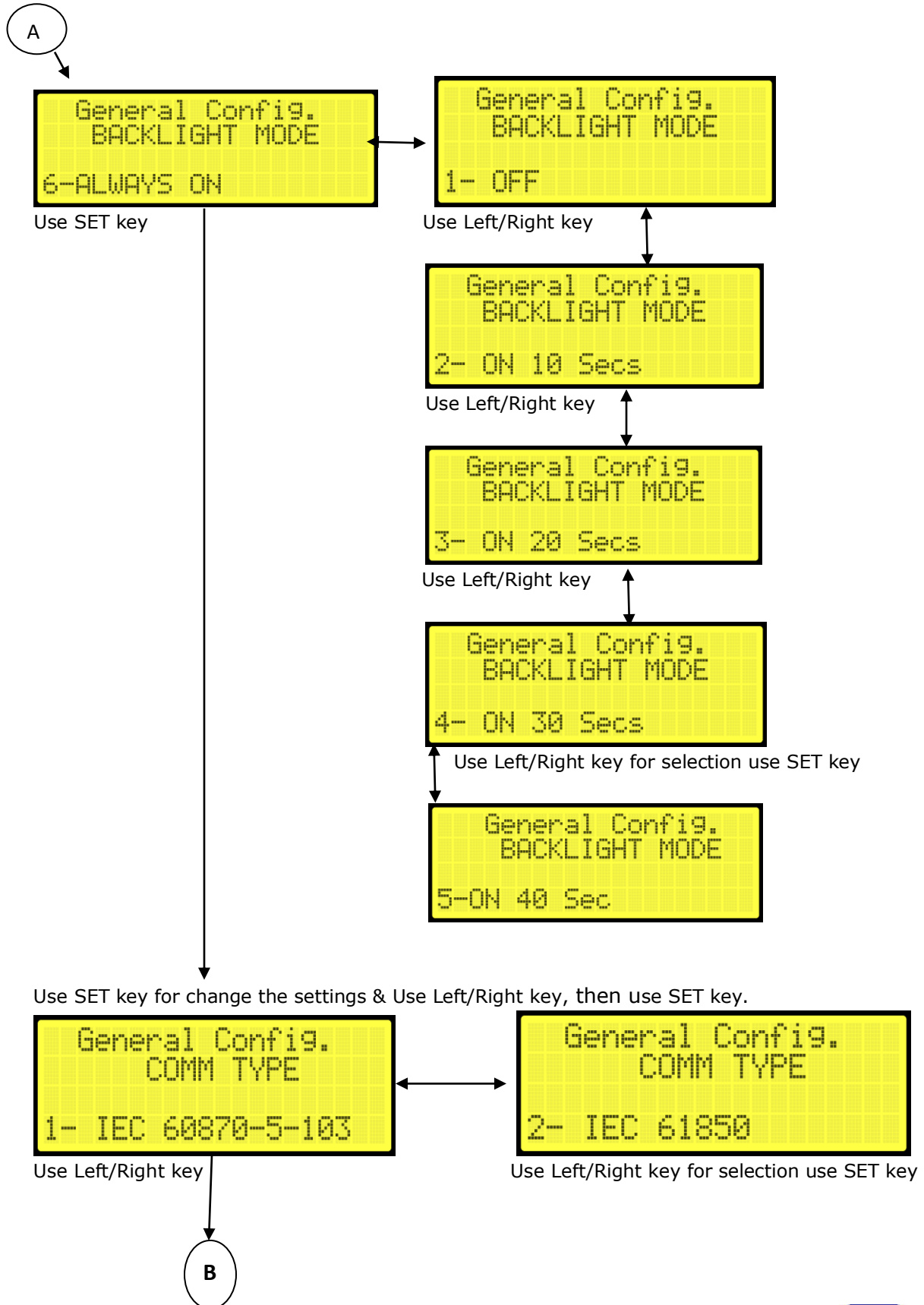



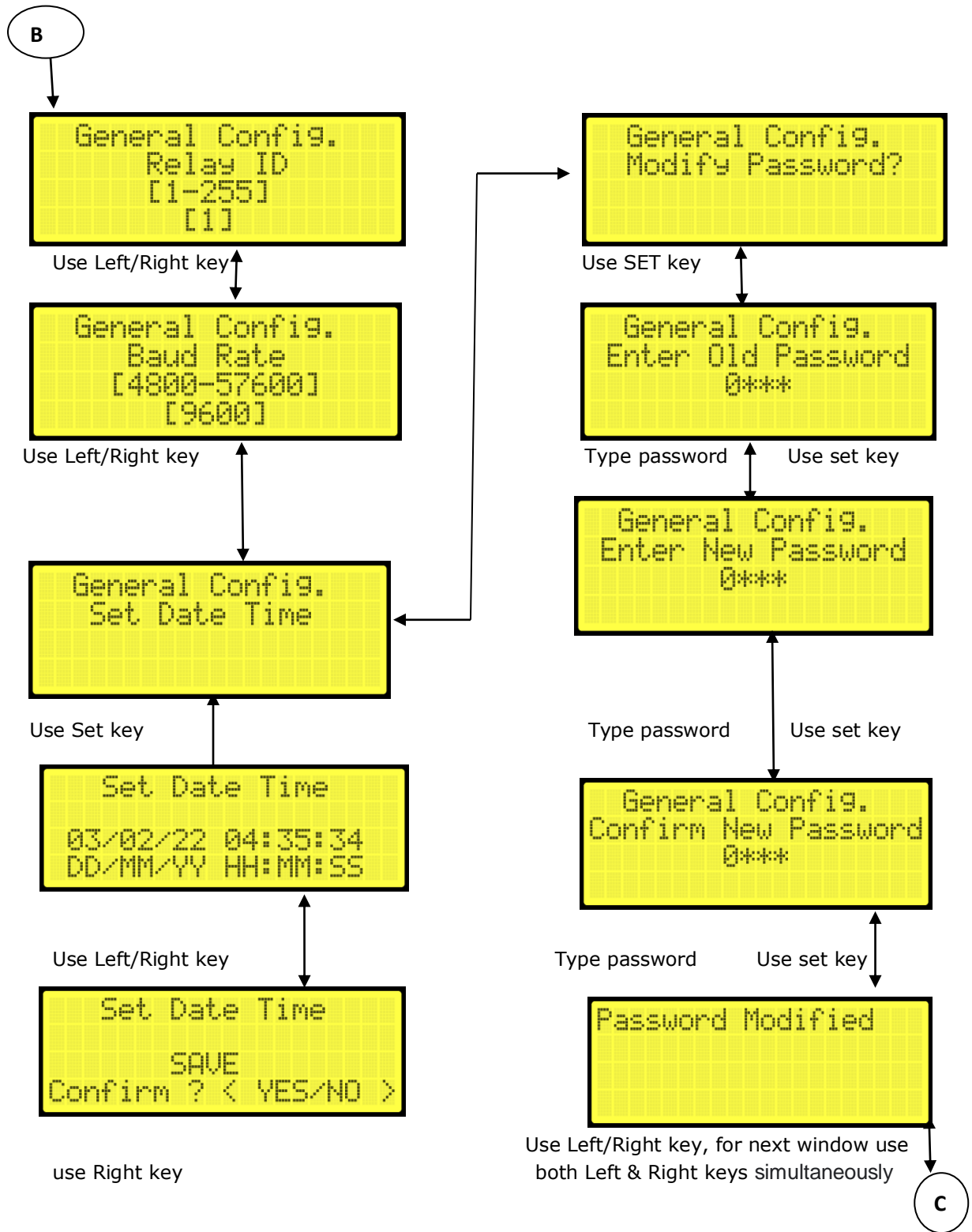

C

```
Relay Setting Mode
2.0C IDMT Protection
```

Use SET key

```
OC IDMT Protection
IDMT CURVE
SELECT CURVE
1-Inverse/3 Sec
```

Use Left/Right key

```
OC IDMT Protection
IDMT CURVE
SELECT CURVE
2-Extremely Inv.
```

Use Left/Right key

```
OC IDMT Protection
IDMT CURVE
SELECT CURVE
3- Very Inv.
```

Use Left/Right key

```
OC IDMT Protection
IDMT CURVE
SELECT CURVE
4-Restricted Inv.
```

Use Left/Right key

```
OC IDMT Protection
IDMT CURVE
SELECT CURVE
5- 1.3 Sec Delay
```

Use Left/Right key

```
OC IDMT Protection
IDMT CURVE
SELECT CURVE
6- Long Time Delay
```

Use Left/Right key

```
OC IDMT Protection
Trip Val(%)
[40-320]
[320]
```

Use Left/Right key

```
OC IDMT Protection
TMS
[0.01-1.00]
[0.01]
```

Use Left/Right key, for next window use both Left & Right keys simultaneously

```
Relay Setting Mode
3.0C INST Protection
```

Use SET key

```
OC INST Protection
(En=1/Dis=0)
[0-1]
[0]
```

Use Left/Right key

```
OC INST Protection
Trip Val(%)
[160-1600]
[160]
```

Use Left/Right key, for next window use both Left & Right keys simultaneously

D

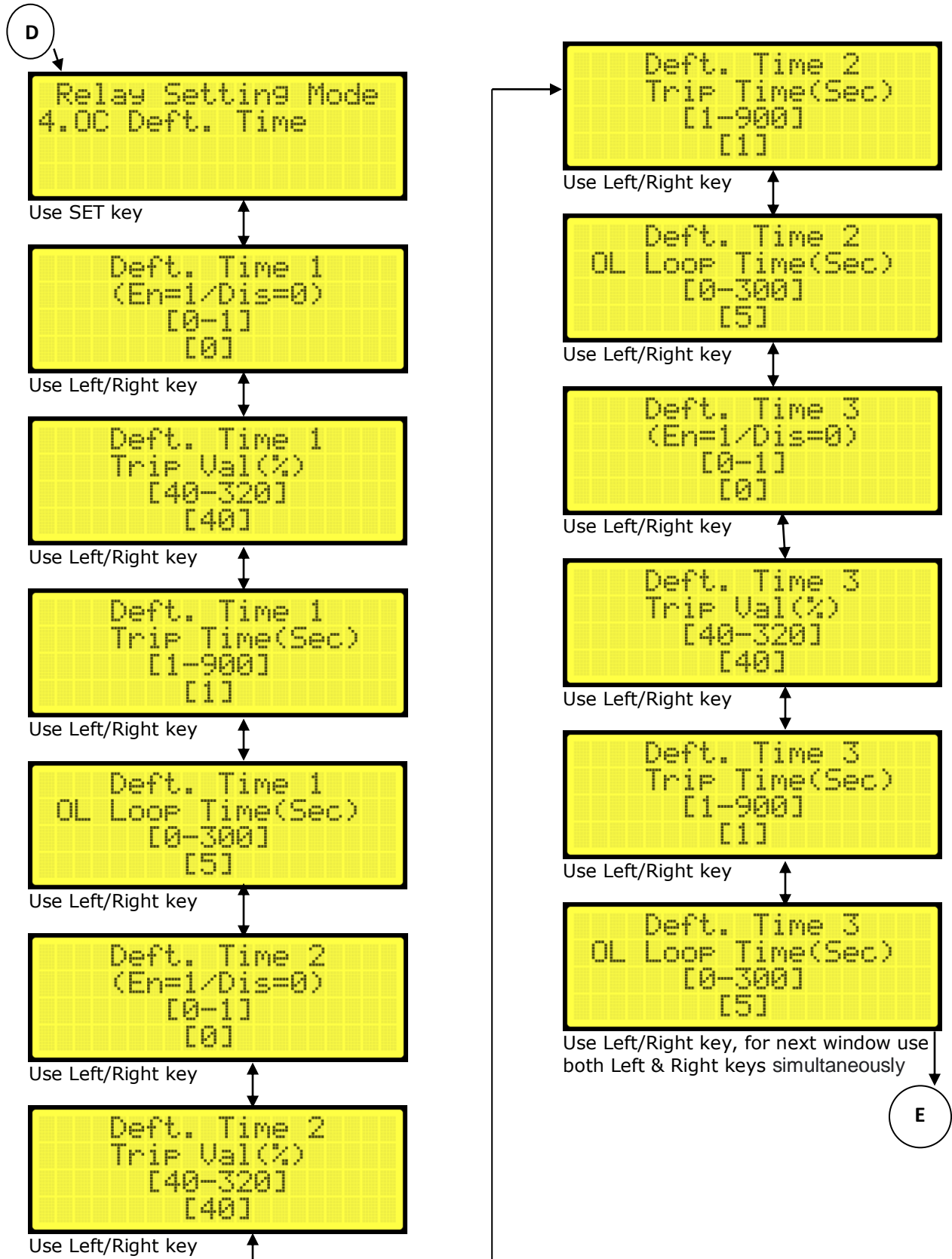

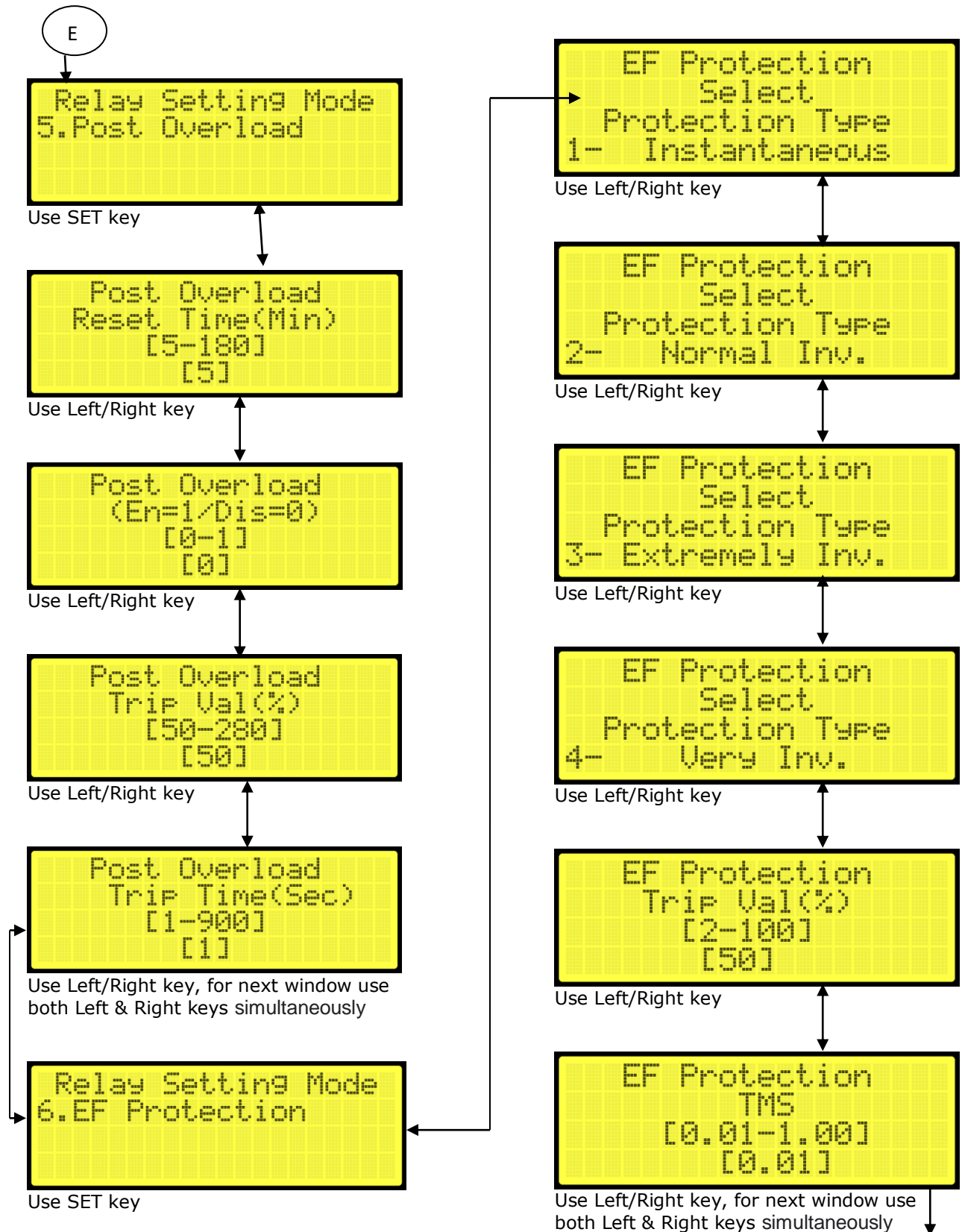

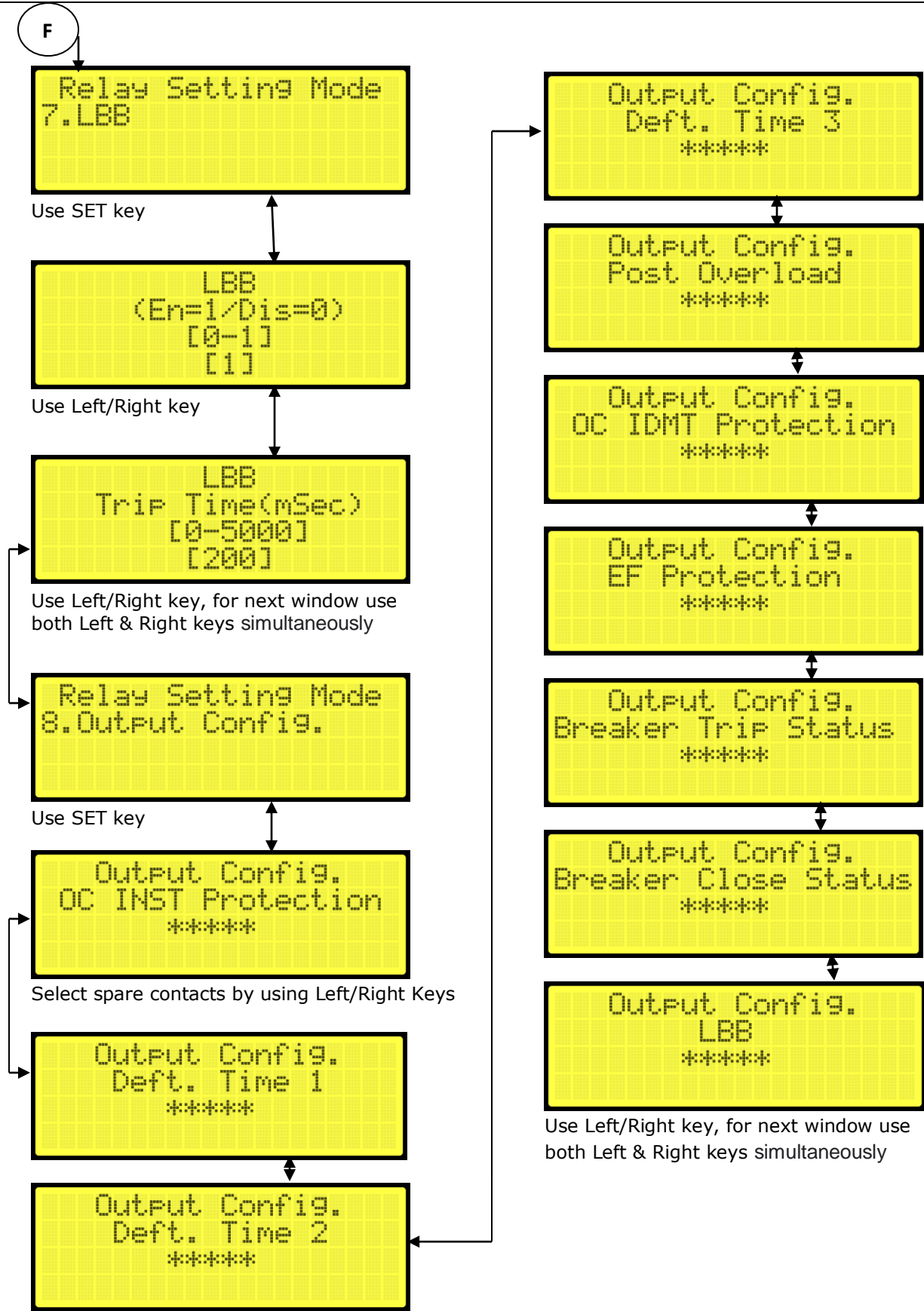

### To access & clear logs



Use this key

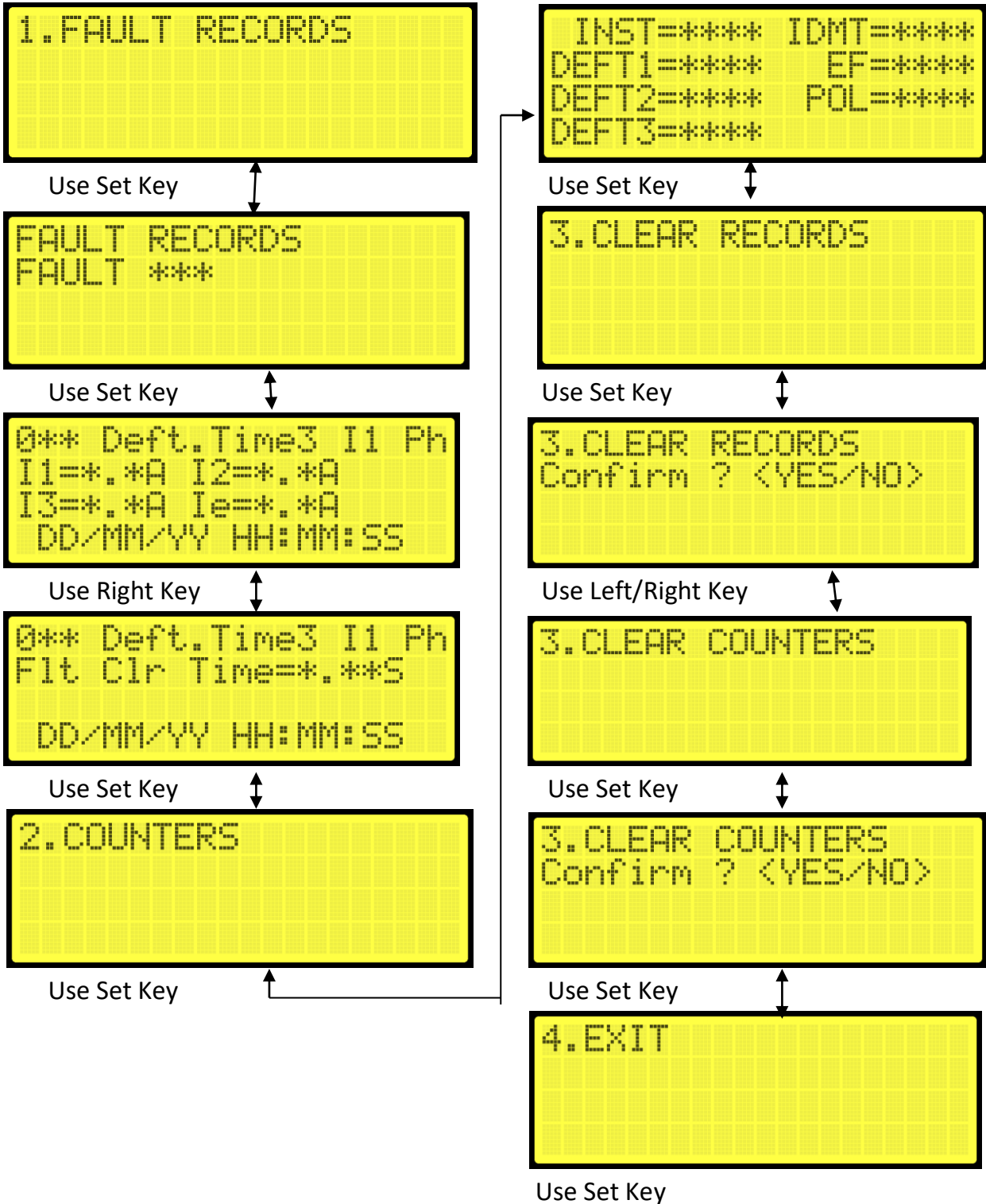



### To view device Info.



Use Right Key

```
Series Name: AN+  
MODEL NO. AR**  
SI No. *****  
SW VER. *.**
```

### For Relay healthiness check & I/O Verification



Use this key

```
1. DATE AND TIME
```

Use Set Key

```
DATE AND TIME  
DD/MM/YY HH:MM:SS
```

Use Right Key

```
2. TEST MODE
```

Use Set Key

```
TEST MODE  
1. BINARY OUTPUT1
```

Use Set Key & enter password

```
B01      TB-A 8-21  
      Gen Trip  
000000000001
```

Use Right Key for next,  
SET key for contact making

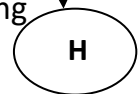





## Binary Output & Input Details

Binary Output 1			Binary Output 2			Binary Input		
BO 1	NAME	TB NUMBER	BO 2	NAME	TB NUMBER	BI	NAME	TB NUMBER
1	NIL		1	AP/GP Alarm	TB B2 - 1 & 3 , 2 & 4	1	AP/GP Alarm	TB B1 - 24
2	Gen Trip	TB A - 8 & 21	2	AP/GP Trip & LOCK	TB B2 - 1 & 5 , 2 & 6	2	AP/GP Trip & LOCK	TB B1 - 21
3	Trip spare	TB A- 9 & 20	3	Buch. Alarm	TB B2 - 1 & 7 , 2 & 8	3	NIL	
4	Trip EF	TB A- 10 & 19	4	Oil Temp Alarm	TB B2 - 1 & 9 , 2 & 10	4	CB Open	TB B1 - 19
5	NIL		5	Wind. Temp Alarm	TB B2 - 1 & 11 , 2 & 12	5	CB Close	TB B1 - 20
6	LBB	TB A- 12 & 17	6	Low Oil Level Alarm	TB B2 - 1 & 13 , 2 & 14	6	RCC Reset	TB B1 - 17
7	SPARE 1	TB A- 13 & 16	7	Inst. OCR	TB B2 - 1 & 15 , 2 & 16	7	NIL	
8	SPARE 2	TB A- 14 & 15	8	TCS	TB B2 - 1 & 17 , 2 & 18	8	Oil Temp Alarm	TB B1 - 15
9	IDMT OCR	TB B1 - 3 & 4	9	LBB	TB B2- 1 & 19 , 2 & 20	9	Buch. Alarm	TB B1 - 16
10	Inst. OCR	TB B1 - 5 & 6	10	EF	TB B2- 1 & 21 , 2 & 22	10	Wind. Temp Alarm	TB B1 - 13
11	EF	TB B1 - 7 & 8	11	IDMT OCR	TB B2- 1 & 23 , 2 & 24	11	Low Oil Level Alarm	TB B1 - 14
12	Relay Error	TB B1 - 1 & 2	12	Def Time OCR	TB B2- 1 & 25 , 2 & 26	12	TCS 1	TB B1 - 11 & 12
						13	TCS 2	TB B1 - 9 & 10

### Binary Output 1

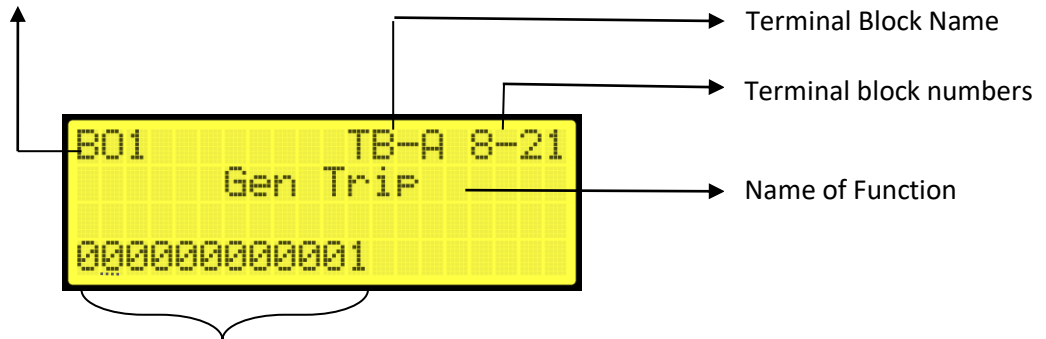

Binary Output Contacts. Use Left</>Right key for selecting previous or next contact & moving cursor also change the corresponding name in display. For make & reset contact use SET (↵) key.

### Binary Output 2

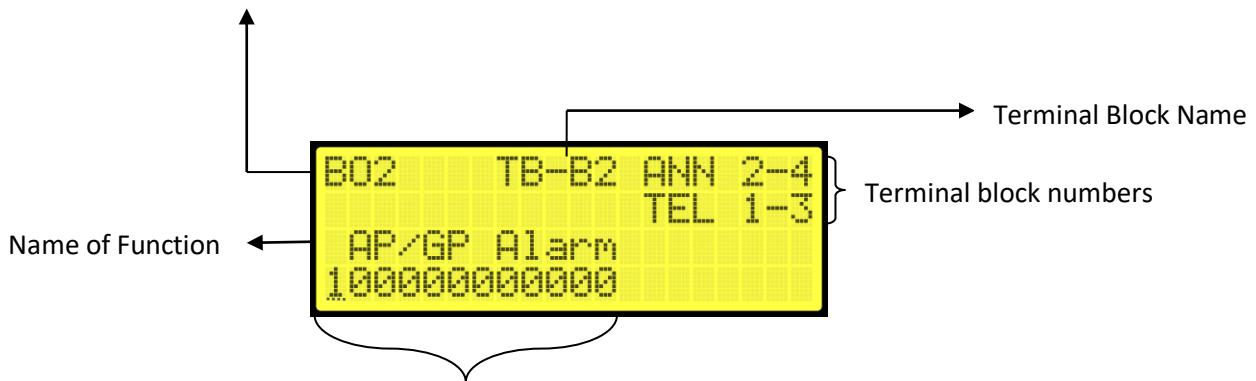

Binary Output Contacts. Use left</>Right key for selecting previous or next contact & moving cursor also change the corresponding name in display. For make & reset contact use SET (↵) key.

**NOTE:** TB B2 – 1 TELE COMMON (+110Vdc)  
TB B2 – 2 ANNU COMMON (+ve common from annunciator)

### Binary Input

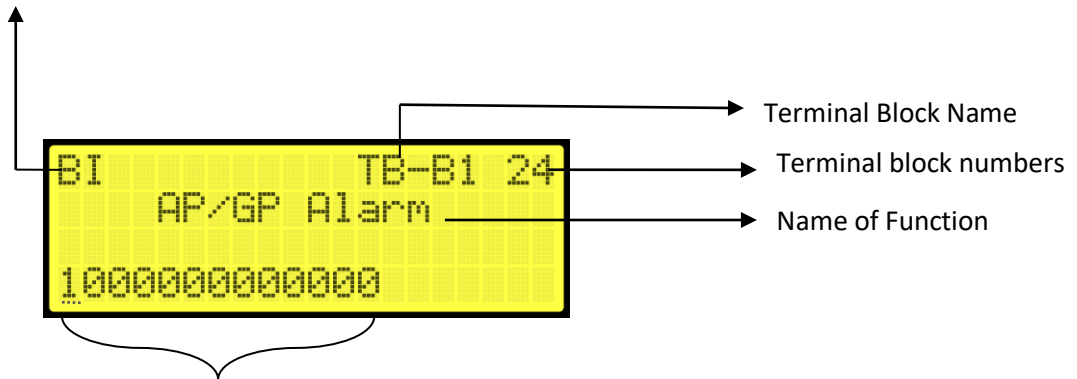

Use left</>Right key for selecting previous or next contact & moving cursor also change the corresponding name in display. When 110 DC (-ve) permanently supplied to the TB-B1-23 as status common and 110 DC (+ve) is given to the status pulse corresponding TB numbers in TB-B1.

# TECHNICAL DATA & CHARACTERISTIC CURVES

**CONTENTS**

DESCRIPTION OF PROTECTION FUNCTIONS

---

TECHNICAL SPECIFICATIONS

---

GENERAL SETTINGS

---

TB DETAILS

---

SETTING GUIDELINES

---

RELAY CONFORMING STANDARDS

---

## DESCRIPTION OF PROTECTION FUNCTIONS

### 1. Instantaneous Over Current Protection

In instantaneous over current protection, relay operates without intentional time delay. Its operating time is within 20ms for 5 times of fault current.

### 2. IDMT Over Current Protection

Inverse time over-current Relay is one in which the time of actuation of Relay decreases as the fault current increases. The more the fault current the lesser will be the time of operation of the Relay.

For Standard inverse characteristics, as per IEC trip time is as follows

$$t = (TMS * K) / ((PSM)^\alpha - 1)$$

Where, **t = Operating time in second**

**TMS = Time multiplier setting**

**PSM = Fault Current/Relay Setting Current**

The values of coefficients K and  $\alpha$  for the different curves are as seen in table below

Relay Operating Characteristics	K	$\alpha$
Inverse/3 Sec delay	0.14	0.02
Very Inverse	13.5	1
Extremely Inverse	80	2
Long Time Inverse	120	1

Other than IEC curves the following characteristics also available in the module

#### 1. Restricted Inverse curve

$$t = TMS / (0.339 - (0.238/PSM))$$

Where,

**TMS = Time Multiplier Setting (TMS)**

**t = Operating time in second**

**TMS = Time multiplier setting**

**PSM = Fault Current/Relay Current Setting**

#### 2. 1.3 Second Delay Curve

$$t = 1.3 * TMS / \log[PSM]$$

Where,

**TMS = Time Multiplier Setting (TMS)**

**t = Operating time in second**

**TMS = Time multiplier setting**

**PSM = Fault Current/Plug Setting**

#### 3. Definite Time Over Current Protection

This element gives protection during over load condition. This helps to utilize the maximum capacity of transformer.

#### 4. Earth Fault Protection/ REF

Relay consists of separate input for monitoring earth fault current. During normal load and through fault condition, current read by relay is zero, but when there is an unbalance in phases the relay will trip instantly. Its operating time is with in 30ms for 5 times of fault current.

#### 5. Trip Circuit Supervision

Relay consists of two numbers of trip circuit supervisions (Post close and pre close). The relay continuously monitors the tripping coil DC (110V –ve) supply through the NC or NO contacts of the Circuit breaker in both open & closed condition. If any discontinuity is observed, the relay generates alarm signal.

### TECHNICAL SPECIFICATIONS

Sl. No	Specification	REF	Particulars
1.	Auxiliary Supply	V <sub>DC</sub>	45 to 260VDC
2.	Current Input (rated)	I	5A AC
3.	Frequency	F <sub>n</sub>	50 Hz
4.	VA Burden on CT		Less than 0.5 VA
5.	VA burden on Aux		Less than 15 Watts(energized) Less than 10 watts( de-energized)
6.	Operating Temp Range		-25°C to + 55 °C
7.	Max. & Minimum relative humidity		5% to 95%
8.	Continuous Current Carry Capacity of CT		4In; 20A
9.	Thermal Withstand for CT		100In for 1 sec
10.	Contact details		
11.	a) Current carrying capacity		5A
	b) Making and carry for 200 msec at 110V DC		30A
	c) Making capacity at 250V,50-60Hz AC		5A
	d)Breaking Capacity AC 220V, 50-60Hz, Cos $\phi$ =0.4 i) DC 220V, L/R= 45ms		5A 0.5A
12.	Type of communication ports		RJ45 (front) and RS485 (IEC60870-5-103)& RJ45/LC FIBER (Rear for IEC 61850)
13.	Overall dimensions		
	Width		263 mm
	Height		173 mm
	Depth		300 mm
14.	Weight		4.8 kg approx.

RELAY SETTINGS

Settings	Particulars
<b>Password protection (YES/NO)</b>	<b>0000-9999</b>
<b>1. General configuration</b>	
Line CT Primary	5-5000 in steps of 1
Earth CT Primary	5 -5000 in steps of 1
Trip Ckt Supervision 1	Enable/Disable
Trip Ckt Supervision 2	Enable/Disable
Post fault cycles	0-5 in steps of 1
Back light	1 - 10S 2- 20S 3 - 30S 4 - 40S
Communication Type	1 - IEC 60870-5-103 2 - IEC 61850
Relay ID	1-255 in steps of 1
Baud Rate	4800-57600 in steps of 200
Set Date & Time	DD MM YYYY
Modify Password	
<b>2. OC IDMT Protection</b>	
IDMT Curve	1- Normal Inverse/ 3 Sec Delay 2- Extremely Inverse 3- Very Inverse 4- Restricted Inverse 5- 1.3 Sec Delay 6- Long Time Delay
Trip Val (%)	40-320 in steps of 1
TMS	0.01-1.00 in steps of 0.01
<b>3. OC INST Protection</b>	
OC INST Protection	EN/DIS
Trip Val (%)	160-1600 in steps of 1
<b>4. OC Deft. Time</b>	
<b>Deft. Time 1</b>	EN/DIS
Trip Val (%)	40-320 in steps of 1
Trip Time(Sec)	1-900 in steps of 1
OL Loop Time(Sec)	0-300 in steps of 1



<b>Deft. Time 2</b>	EN/DIS
Trip Val (%)	40-320 in steps of 1
Trip Time(Sec)	1-900Sec in steps of 1
OL Loop Time(Sec)	0-300Sec in steps of 1
<b>Deft. Time 3</b>	
Trip Val (%)	40-320% in steps of 1
Trip Time(Sec)	1-900 in steps of 1 Sec
OL Loop Time(Sec)	0-300 in steps of 1 Sec
<b>5. Post Over load Protection</b>	
Post Overload	EN/DIS
Trip Val (%)	50-280 in steps of 1%
Trip Time(Sec)	1-900 in steps of 1 Sec
Reset Time(Min)	5-180 in steps of 1 Min
<b>6. EF Prot.</b>	
EF Characteristics	1 – Inst. 2 – Inverse/3 Sec Delay 3 – Extremely Inverse 4 – Very Inverse
Trip Val (%)	2-100% in steps of 1
TMS	0.01-1 in steps of 0.01
<b>7. LBB</b>	
LBB	EN/DIS
Trip Time	0-5000 in steps of 1
<b>Operating Time</b>	
i) IDMT OCR Protection	Depends on curve & TMS setting
ii) Instantaneous OCR Protection	within 20ms for 5 times current
iii)) Earth Fault/REF Protection	within 30ms for 5 times current
iv) LBB	Depends on Time setting

TB DETAILS

NUMERICAL OC+EF/REF PROTECTION RELAY

AR56

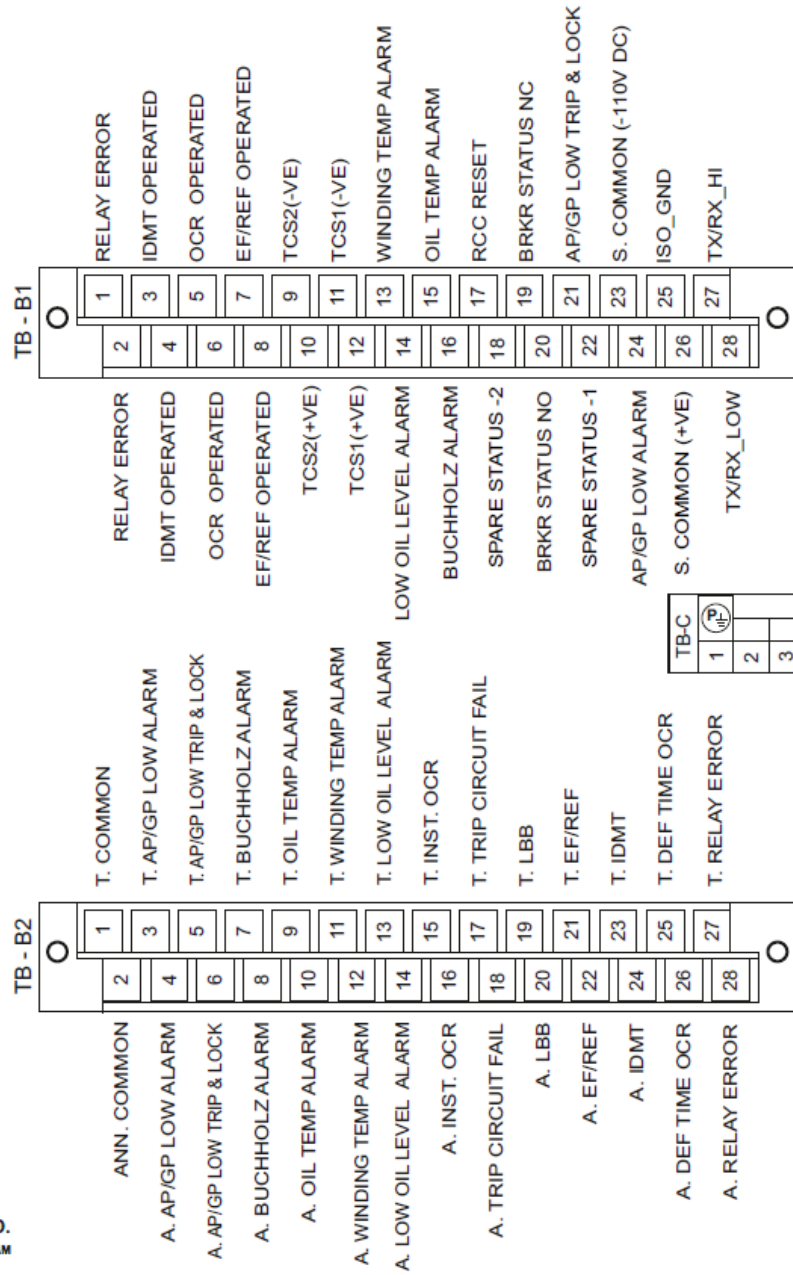
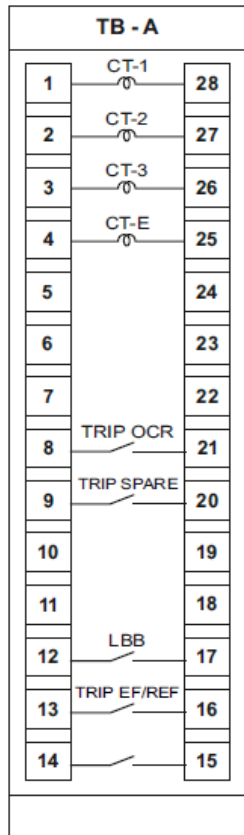

ALUMINIUM INDUSTRIES LTD.  
RELAYS DIVISION THIRUVANANTHAPURAM

**RELAY CONFORMING STANDARDS**

The relay conforms to the following standards:

SI No.	Standards	Description
I.	IEC 60255-16	IMPEDANCE MEASURING RELAY.
II.	IEC 60255-151	FUNCTIONAL REQUIREMENTS FOR OVER/UNDER CURRENT PROTECTION.
III.	IEC 60255-5	INSULATION COORDINATION OF MEASURING RELAYS AND PROTECTION EQUIPMENT- REQUIREMENTS AND TESTS.
IV.	IEC 60255-1	MEASURING RELAYS AND PROTECTION EQUIPMENT- COMMON REQUIREMENTS.
V.	IEC 60255-21-1	VIBRATION TESTS (SINUSODIAL)
VI.	IEC 60255-21-2	SHOCK AND BUMP TESTS
VII.	IEC 60255-21-3	SEISMIC TESTS
VIII.	IEC 60255-27	PRODUCT SAFETY REQUIREMENT.
IX.	IEC 60255-26	ELECTROMAGNETIC COMPATIBILITY REQUIREMENT.
X.	IEC 60529	DEGREES OF PROTECTION PROVIDED BY ENCLOSURES (IP CODE)
XI.	IEC 61810-2	RELIABILITY.
XII.	IS 2705 (PART II, III&IV)	PROTECTIVE CURRENT TRANSFORMERS.
XIII.	IS 3156 (PART II/III)	MEASURING/PROTECTIVE VOLTAGE TRANSFORMERS.
XIV.	IS 3231 (PART 1 TO 3)	ELECTRICAL RELAYS FOR POWER SYSTEM PROTECTION.
XV.	IS 8686	STATIC PROTECTIVE RELAYS.
XVI.	IEC 60068-2	ENVIRONMENTAL TESTS.
XVII.	IEC 60529	IP 54 TEST
XVIII.	IEC 60870-5-103	COMMUNICATION PROTOCOL
XIX.	IEC 61850	COMMUNICATION PROTOCOL

# TROUBLE SHOOTING

Under normal working conditions, the 'PROTECTION HEALTHY LED' provided in the front panel of the relay glows green. The same LED turns amber to recognize any fault inside the relay itself.

Following are certain guidelines for the relay to identify the nature of fault and necessary checking procedures to be adopted at site so that relay can be rectified suitably.

SI. No.	Faults	Checks	Causes
1	No power ON Indication or No display.	1. Check the auxiliary DC supply to the relay rear terminals  2. Check the continuity of the output terminal, after disconnecting the wires.	1. Due to power supply failure, the LED turns off. 2. The varistor may short circuited to protect internal circuitry on transients
2	Current Not reading/ Out of tolerance limit.	1. Refer TB sticker for CT inputs. 2. Check for the earthing of CT. 3. Check if the terminals of TB-A is connected properly or for any lose contact. 4. Check CT ratio and multiplying factor if any. 5. Check the continuity of the output terminal, after disconnecting the wires. After checking of the above, measure the current using calibrated Clamp-On meter. If not OK, intimate to works.	1. The CT connector is having shorting facility. If the connector is not tight, CT secondary may get some low resistance path through the connector itself. 2. If CT is not properly earthed, there is a chance of leakage current that may cause error in CT reading.
4	Relay Error Indication	1. Intimate to works. 2. Press H.RST key in the relay front panel.	1. Supply variation to internal PCB's. 2. DC supply fail.

**SCADA COMMUNICATION INTERFACE AS PER IEC  
60870-5-103 PROTOCOL**

**MODEL – AR 56**

**RELAY DESIGNED AS PER RDSO SPECIFICATION NO.  
TI/SPC/PSI/PROTCT/7101**



**ALUMINIUM INDUSTRIES LIMITED  
RELAYS DIVISION**

**Version            1.1**  
**Date                21/02/2024**

## OVERVIEW

IEC 60870-5-103 is a standard for power system control and associated communications. It defines a companion standard that enables interoperability between protection equipment and devices of a control system in a substation. The device complying with this standard can send the information using two methods for data transfer - either using the explicitly specified application service data units (ASDU) or using generic services for transmission of all the possible information.

The IEC 60870-5 protocol is based on the three-layer reference model 'Enhanced Performance Architecture' (EPA), as specified in clause 4 of IEC 60870-5-3. The physical layer copper-wire based system that provides binary symmetric and memoryless transmission.

The link layer consists of a number of link transmission procedures, using explicit Link Protocol Control Information (LPCI), that are capable of carrying Application Service Data Units (ASDUs) as link user data. The link layer uses a selection of frame formats to provide the required integrity, efficiency, and convenience of transmission.

The application layer contains a number of application functions that involve the transmission of Application Service Data Units (ASDUs) between source and destination.

The application layer of this companion standard does not use explicit Application Protocol Control Information (APCI). This is implicit in the contents of the ASDU Data Unit Identifier and in the type of link service used.

## PHYSICAL LAYER

Connection is possible with IEC 60870-5-103 via rear RS485 port of relay as seen in figure 1 below.

1. TX/RX\_HI correspond to Data +ve.
2. TX/RX\_LOW correspond to Data -ve.
3. ISO\_GND correspond to GND.

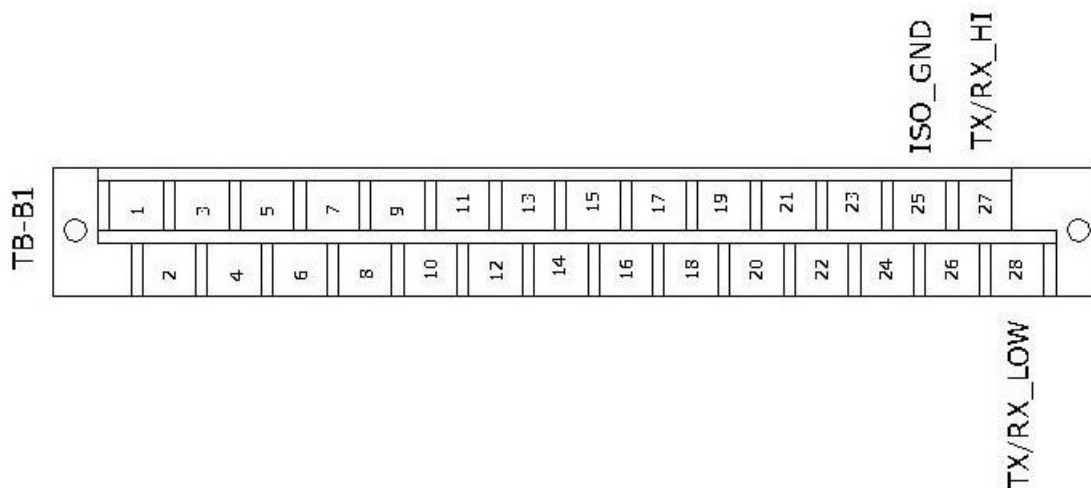

Figure 1

## GENERAL INFORMATION

**Relay ID:** Settable from 1 to 255 via relay HMI.

**Baud Rate:** Settable from 4800 – 57600 via relay HMI.

**No. of data bits:** 8

**No of stop bits:** 1

**Parity:** None

**Measurand Scaling Factor:** 2.4

## PROTOCOL MAPPING

**INFORMATION NUMBER:** INF

**ASDU TYPE:** TYP

**CAUSE OF TRANSMISSION:** COT

**FUNCTION NUMBER:** FUN

**GENERAL INTERROGATION:** GI, marked with 'X' wherever applicable.

**COM:** Indicates whether relay generated event on rising edge only (0 - 1) indicated by ↑ or both rising and falling edge (0-1 and 1-0) indicated by ↑↓.

## SYSTEM FUNCTIONS IN MONITOR DIRECTIONS

DESCRIPTION	GI	ASDU TYPE	FUN	INF	COT	COM
End of general interrogation	-	8	255	0	10	GLB
Time synchronization	-	6	255	0	8	GLB
Reset FCB	-	5	160	2	3	According to main FUN
Reset CU	-	5	160	3	4	According to main FUN
Reset CU/Start/Restart	-	5	160	4	5	According to main FUN

## STATUS INDICATION IN MONITOR DIRECTION

DESCRIPTION	GI	ASDU TYPE	FUN	INF	COT	COM
Protection Healthy/Active	-	1	160	18	1	↑↓
RCC Reset	-	1	160	19	1	↑
Local Parameter Settings (Change)	-	1	160	22	1	↑
Buchholz Alarm	X	1	160	27	1,9	↑↓
Winding temp alarm	X	1	160	28	1,9	↑↓
Oil Temp Alarm	X	1	160	200	1,9	↑↓
Low oil level alarm	X	1	160	201	1,9	↑↓
AP/GP low alarm	X	1	160	29	1,9	↑↓
AP/GP trip & lock	X	1	160	30	1,9	↑↓
CB NC (FDR CB open)	X	1	160	124	1,9	↑↓
CB NO (FDR CB close)	X	1	160	125	1,9	↑↓
Spare	X	1	160	31	1,9	↑↓



Relay Error	-	1	160	40	1	↑
-------------	---	---	-----	----	---	---

### SUPERVISION INDICATIONS IN MONITOR DIRECTION

DESCRIPTION	GI	ASDU TYPE	FUN	INF	COT	COM
Trip circuit supervision	X	1	160	36	1,9	↑↓

### FAULT INDICATION IN (MONITOR DIRECTIONS)

DESCRIPTION	GI	ASDU TYPE	FUN	INF	COT	COM
Breaker Failure (LBB)	X	2	160	85	1,9	↑↓
Start/Pickup IDMT – I1	X	2	160	170	1,9	↑↓
Start/Pickup I> (Inst OCR) – I1	X	2	160	171	1,9	↑↓
Start/pickup I>> (Def OCR stage 1) – I1	X	2	160	172	1,9	↑↓
Start/pickup I>>> (Def OCR stage 2) – I1	X	2	160	173	1,9	↑↓
Start/pickup I>>>> (Def OCR stage 3) – I1	X	2	160	174	1,9	↑↓
Start/Pickup Post Overload – I1	X	2	160	175	1,9	↑↓
Start/Pickup IDMT – I2	X	2	160	176	1,9	↑↓
Start/Pickup I> (Inst OCR) – I2	X	2	160	177	1,9	↑↓
Start/pickup I>> (Def OCR stage 1) – I2	X	2	160	178	1,9	↑↓
Start/pickup I>>> (Def OCR stage 2) – I2	X	2	160	179	1,9	↑↓
Start/pickup I>>>> (Def OCR stage 3) – I2	X	2	160	180	1,9	↑↓
Start/Pickup Post Overload – I2	X	2	160	181	1,9	↑↓
Start/Pickup IDMT – I3	X	2	160	182	1,9	↑↓
Start/Pickup I> (Inst OCR) – I3	X	2	160	183	1,9	↑↓
Start/pickup I>> (Def OCR stage 1) – I3	X	2	160	184	1,9	↑↓
Start/pickup I>>> (Def OCR stage 2) – I3	X	2	160	185	1,9	↑↓
Start/pickup I>>>> (Def OCR stage 3) – I3	X	2	160	186	1,9	↑↓
Start/Pickup Post Overload – I3	X	2	160	187	1,9	↑↓
Start/Pickup IN> (REF/EF)	X	2	160	188	1,9	↑↓
Trip IDMT – I1	-	2	160	69	1	↑↓
Trip I> (Inst OCR) - I1	-	2	160	90	1	↑↓
Trip I>> (Def OCR stage – 1) – I1	-	2	160	91	1	↑↓
Trip I>>> (Def OCR stage – 2) –	-	2	160	94	1	↑↓

I1						
Trip I>>>> (Def OCR stage – 3) – I1	-	2	160	95	1	↑↓
Trip Post Overload – I1	-	2	160	96	1	↑↓
Trip IDMT – I2	-	2	160	70	1	↑↓
Trip I> (Inst OCR) – I2	-	2	160	97	1	↑↓
Trip I>> (Def OCR stage – 1) – I2	-	2	160	98	1	↑↓
Trip I>>> (Def OCR stage – 2) – I2	-	2	160	99	1	↑↓
Trip I>>>> (Def OCR stage – 3) – I2	-	2	160	100	1	↑↓
Trip Post Overload – I2	-	2	160	101	1	↑↓
Trip IDMT – I3	-	2	160	71	1	↑↓
Trip I> (Inst OCR) – I3	-	2	160	102	1	↑↓
Trip I>> (Def OCR stage – 1) – I3	-	2	160	103	1	↑↓
Trip I>>> (Def OCR stage – 2) – I3	-	2	160	104	1	↑↓
Trip I>>>> (Def OCR stage – 3) – I3 1	-	2	160	105	1	↑↓
Trip Post Overload – I3	-	2	160	106	1	↑↓
Trip IN> (REF/EF)	-	2	160	92	1	↑↓

### MEASURANDS IN MONITOR DIRECTION

Measurands are scaled with a scaling factor of 2.4. To obtain the actual value from raw value, following formulae can be used.

$$\text{Actual Value} = \left( \frac{\text{Raw Value} \times 2.4}{4096} \right) \times \text{Primary CT/PT value}$$

DESCRIPTION	GI	ASDU TYPE	FUN	INF	COT	COM
Measurand supervision I1	-	9	160	148	2	↑↓
Measurand supervision I2	-	9	160	149	2	↑↓
Measurand supervision I3	-	9	160	150	2	↑↓
Measurand supervision IN	-	9	160	151	2	↑↓

### TIME TAGGED MEASURANDS IN MONITOR DIRECTIONS

DESCRIPTION	GI	ASDU TYPE	FUN	INF	COT	COM
Fault Current – I1	-	4	160	152	1	↑↓
Fault Current – I2	-	4	160	153	1	↑↓
Fault Current – I3	-	4	160	154	1	↑↓
Fault Current – IN	-	4	160	155	1	↑↓

**STANDARD INFORMATION NUMBERS IN CONTROL DIRECTION****SYSTEM FUNCTIONS IN CONTROL DIRECTION**

DESCRIPTION	GI	ASDU TYPE	FUN	INF	COT	COM
Initiation of general interrogation	-	7	255	0	9	GLB
Time Synchronization	-	6	255	0	8	GLB

**GENERAL COMMANDS IN CONTROL DIRECTION**

DESCRIPTION	GI	ASDU TYPE	FUN	INF	COT	COM
LED (RCC) RESET	-	20	160	19	20	↑ (PULSE)
CB Open	-	20	160	120	20	↑↓ (PULSE)
CB Close	-	20	160	121	20	↑↓ (PULSE)

**DISTURBANCE RECORD EXTRACTION**

The disturbance record extraction procedure in ALIND relays is in conformance with IEC 60870-5-103 standard definition.

**ANALOG CHANNEL INFORMATION IN AR 56**

AR 56		
FUN	ACC	PARAMETER
160	1	I1
160	2	I2
160	3	I3
160	4	IN
160	5	X
160	6	X
160	7	X
160	8	X

**DIGITAL CHANNEL (TAGS) INFORMATION IN AR 56**

<b>AR 56</b>			
<b>TAG POSITION</b>	<b>FUN/INF NUMBER</b>	<b>SEMANTICS ACCORDING TO TAG POSITION</b>	<b>INPUT/OUTPUT</b>
0	160/84	GENERAL PICKUP	OUTPUT
1	160/68	GENERAL TRIP	OUTPUT
2	160/69	IDMT TRIP I1	OUTPUT
3	160/90	INST OCR I> TRIP I1	OUTPUT
4	160/91	DEF OCR STAGE 1 I>> TRIP I1	OUTPUT
5	160/94	DEF OCR STAGE 2 I>>> TRIP I1	OUTPUT
6	160/95	DEF OCR STAGE 3 I>>>> TRIP I1	OUTPUT
7	160/96	POST OVERLOAD I1	OUTPUT
8	160/70	IDMT TRIP I2	OUTPUT
9	160/97	INST OCR I> TRIP I2	OUTPUT
10	160/98	DEF OCR STAGE 1 I>> TRIP I2	OUTPUT
11	160/99	DEF OCR STAGE 2 I>>> TRIP I2	OUTPUT
12	160/100	DEF OCR STAGE 3 I>>>> TRIP I2	OUTPUT
13	160/101	POST OVERLOAD I2	OUTPUT
14	160/71	IDMT TRIP I3	OUTPUT
15	160/102	INST OCR I> TRIP I3	OUTPUT
16	160/103	DEF OCR STAGE 1 I>> TRIP I3	OUTPUT
17	160/104	DEF OCR STAGE 2 I>>> TRIP I3	OUTPUT
18	160/105	DEF OCR STAGE 3 I>>>> TRIP I3	OUTPUT
19	160/106	POST OVERLOAD I3	OUTPUT
20	160/92	REF/EF TRIP IN	OUTPUT
21	160/85	LBB TRIP	OUTPUT
22	160/27	BUCHHOLZ ALARM	INPUT
23	160/28	WINDING TEMP. HIGH ALARM	INPUT
24	160/200	OIL TEMP. HIGH ALARM	INPUT
25	160/201	LOW OIL LEVEL ALARM	INPUT
26	160/124	CB NC (BREAKER OPEN)	INPUT
27	160/125	CB NO (BREAKER CLOSE)	INPUT
28	160/30	AP/GP LOW TRIP & LOCK	INPUT
29	160/29	AP/GP LOW ALARM	INPUT
30	160/36	TRIP CIRCUIT FAIL	INPUT

Model Implementation Conformance Statement  
for the IEC 61850 interface in ALIND AR 56 relay version 1.0

Based on  
UCA International Users Group  
Testing Sub Committee

Template version 1.0  
Date: April 24, 2008

TITLE: MICS DOCUMENT FOR AR 56 RELAY	MICS Ver.	2.0
	DATE: 21 FEBRUARY 2024	
	ALUMINIUM INDUSTRIES LTD   RELAYS DIVISION, THIRUVANANTHAPURAM	

# 1. Introduction

This model implementation conformance statement is applicable for ALIND AR 56 relay. The definitions of all used Logical Devices, Logical Nodes and their associated Common Data Classes, components and associated enumerated values are also included for completeness.

This MICS document specifies the modelling compared to IEC 61850 Edition 2.

## 2. Logical Device

Logical Device	Description
CONTROL	Controls Domain
MEASUREMENT	Measurements Domain
PROTECTION	Protection Domain
RECORDS	Fault Records Domain
SYSTEM	System Domain

### Logical Device data model

Logical Device	Logical Node Instance	Logical Node type	Description
CONTROL	LLN0	LLN01	LLN0 for Logical Device CONTROL
	CNTRL_GGIO1	GGIO_TRX_3C	IED control 3 no.
MEASUREMENT	LLN0	LLN02	LLN0 for Logical Device MEASURAND
	MTR_MMXN1	MMXN_TRX_MTR	Measurand Value I1, I2, I3, IN
	FLT_MMXN2	MMXN_TRX_FLT	Fault Value I1, I2, I3, IN
PROTECTION	LLN0	LLN03	LLN0 for Logical Device PROTECTION
	IOC1_PIOC1	PIOC_TRX	Instantaneous OCR I1
	IOC2_PIOC2	PIOC_TRX	Instantaneous OCR I2
	IOC3_PIOC3	PIOC_TRX	Instantaneous OCR I3
	EF_PTOC1	PTOC_TRX	Earth Fault IN
	POLD1_PTOC2	PTOC_TRX	Post Overload 1
	POLD2_PTOC3	PTOC_TRX	Post Overload 2
	POLD3_PTOC4	PTOC_TRX	Post Overload 3
	IDMT1_PTOC5	PTOC_TRX	IDMT OCR I1
	IDMT1_PTOC6	PTOC_TRX	IDMT OCR I2
	IDMT1_PTOC7	PTOC_TRX	IDMT OCR I3
	DEF1_I1_PTOC8	PTOC_TRX	Definite time OCR stage 1- I1
	DEF2_I1_PTOC9	PTOC_TRX	Definite time OCR stage 2- I1
	DEF3_I1_PTOC10	PTOC_TRX	Definite time OCR stage 3- I1
	DEF1_I2_PTOC11	PTOC_TRX	Definite time OCR stage 1- I2
DEF2_I2_PTOC12	PTOC_TRX	Definite time OCR stage 2- I2	
DEF3_I2_PTOC13	PTOC_TRX	Definite time OCR stage 3- I2	

	DEF1_I3_PTOC14	PTOC_TRX	Definite time OCR stage 1- I3
	DEF2_I3_PTOC15	PTOC_TRX	Definite time OCR stage 2- I3
	DEF3_I3_PTOC16	PTOC_TRX	Definite time OCR stage 3- I3
	LBB_RBRF1	RBRF_TRX	Breaker Failure
RECORDS	LLN04	LLN04	LLNO for Logical Device RECORDS
	RDRE1	RDRE_TRX	Disturbance recorder
SYSTEM	LLN05	LLN05	LLNO for Logical Device SYSTEM
	LPHD	LPHD_TRX	Physical Device Information
	ALM_GGIO1	GGIO_TRX_ALM3	Alarms
	IND_GGIO2	GGIO_TRX_BI11	Binary Inputs



### 3. Logical Node List

Following list contains list of logical node classes implemented in device

<b>G: Logical Nodes for generic references</b>	
GGIO (Generic Process I/O)	
<b>L: System Logical Nodes</b>	
LLNO (Logical device LN)	
LPHD (Physical device LN)	
<b>M: Logical Nodes for metering and measurement</b>	
MNXN (Non-Phase Related Measurements)	
<b>P: Logical Nodes for protection functions</b>	
PIOC (Instantaneous Overcurrent)	
PTOC (Time Overcurrent)	
<b>R: Logical nodes for protection related functions</b>	
RBRF (Breaker Failure)	
RDRE (Disturbance Recorder Function)	

## 4. Logical Nodes

The following table use

- M: Data object is mandatory in the IEC 61850-7-4 ED.2.
- O: Data object is optional in the IEC 61850-7-4 ED.2 and is used in the device
- E: Data object is extension to the IEC 61850-7-4 ED.2 and is used in the device

### 4.1 Logical Node: CNTRL\_GGIO1

**Description:** Generic Process I/O

**LN Class:** GGIO

Data Object	CDC type	Description	M/O
<b>Common Logical Node Information</b>			
Beh	ENS	Behavior	M
<b>Controls</b>			
SPCSO1	SPC	Generic single point controllable status output (RCC Reset)	O
SPCSO2	SPC	Generic single point controllable status output (CB Open Command)	O
SPCSO3	SPC	Generic single point controllable status output (CB Close Command)	O

### 4.2 Logical Node: ALM\_GGIO1

**Description:** Generic Process I/O

**LN Class:** GGIO

Data Object	CDC type	Description	M/O
<b>Common Logical Node Information</b>			
Beh	ENS	Behavior	M
<b>Status Information</b>			
Alm1	SPS	General Single Alarm (Protection Healthy/Active)	O
Alm2	SPS	General Single Alarm (Relay Error)	O
Alm3	SPS	General Single Alarm (Local Parameter Setting Change)	O

### 4.3 Logical Node: IND\_GGIO2

**Description:** Generic Process I/O

**LN Class:** GGIO

Data Object	CDC type	Description	M/O
<b>Common Logical Node Information</b>			
Beh	ENS	Behavior	M
<b>Status Information</b>			
Ind1	SPS	General Indication (RCC Reset)	O
Ind2	SPS	General Single Alarm (Trip Circuit Supervision)	O
Ind3	SPS	General Indication (Buchholz Alarm)	O
Ind4	SPS	General Indication (Winding Temp High Alarm)	O
Ind5	SPS	General Indication (Oil Temp High Alarm)	O
Ind6	SPS	General Indication (Low Oil Level Alarm)	O

Ind7	SPS	General Indication (AP/GP low alarm)	O
Ind8	SPS	General Indication (AP/GP trip & lock)	O
Ind9	SPS	General Indication (CB NC Status)	O
Ind10	SPS	General Indication (CB NO Status)	O
Ind11	SPS	General Indication (Spare Status)	O

#### 4.4 Logical Node: LLN0

**Description:** Logical Node Zero

**LN Class:** LLN0

Data Object	CDC type	Description	M/O
<b>Common Logical Node Information</b>			
Beh	ENS	Behavior	M
Mod	ENC	Mode	M
Health	ENS	Health	M
NamPlt	LPL	Name Plate	M

#### 4.5 Logical Node: LPHD1

**Description:** Physical Device Information

**LN Class:** LPHD

Data Object	CDC type	Description	M/O
<b>Descriptions</b>			
PhyNam	DPL	Device Name Plate	M
<b>Status Information</b>			
PhyHealth	ENC	Device Health	M
Proxy	ENS	Indicates if this Logical Node is Proxy	M

#### 4.6 Logical Node: MTR\_MMVN1

**Description:** Non Phase Related Measurements (Measurand values)

**LN Class:** MMVN

Data Object	CDC type	Description	M/O/E
<b>Common Logical Node Information</b>			
Beh	ENS	Behavior	M
<b>Measured and Metered Values</b>			
Amp1	MV	Measurand Current I1	E
Amp2	MV	Measurand Current I2	E
Amp3	MV	Measurand Current I3	E
Amp4	MV	Measurand Current IN	E

#### 4.7 Logical Node: FLT\_MMXN2

**Description:** Non-Phase Related Measurements (Fault Values)

**LN Class:** MMXN

Data Object	CDC type	Description	M/O/E
<b>Common Logical Node Information</b>			
Beh	ENS	Behavior	M
<b>Measured and Metered Values</b>			
Amp1	MV	Fault Current I1	E
Amp2	MV	Fault Current I2	E
Amp3	MV	Fault Current I3	E
Amp4	MV	Fault Current IN	E

#### 4.8 Logical Node: IOC1\_PIOC1

**Description:** Instantaneous Overcurrent Protection

**LN Class:** PIOC

Data Object	CDC type	Description	M/O
<b>Common Logical Node Information</b>			
Beh	ENS	Behavior	M
<b>Status Information</b>			
Str	ACD	Start	O
Op	ACT	Operate	M

#### 4.9 Logical Node: IOC2\_PIOC2

**Description:** Instantaneous Overcurrent Protection

**LN Class:** PIOC

Data Object	CDC type	Description	M/O
<b>Common Logical Node Information</b>			
Beh	ENS	Behavior	M
<b>Status Information</b>			
Str	ACD	Start	O
Op	ACT	Operate	M

#### 4.10 Logical Node: IOC3\_PIOC3

**Description:** Instantaneous Overcurrent Protection

**LN Class:** PIOC

Data Object	CDC type	Description	M/O
<b>Common Logical Node Information</b>			
Beh	ENS	Behavior	M
<b>Status Information</b>			
Str	ACD	Start	O
Op	ACT	Operate	M

**4.11 Logical Node: EF\_PTOC1****Description:** Time Overcurrent**LN Class:** PTOC

Data Object	CDC type	Description	M/O
<b>Common Logical Node Information</b>			
Beh	ENS	Behavior	M
<b>Status Information</b>			
Str	ACD	Start	M
Op	ACT	Operate	M

**4.12 Logical Node: POLD1\_PTOC2****Description:** Time Overcurrent**LN Class:** PTOC

Data Object	CDC type	Description	M/O
<b>Common Logical Node Information</b>			
Beh	ENS	Behavior	M
<b>Status Information</b>			
Str	ACD	Start	M
Op	ACT	Operate	M

**4.13 Logical Node: POLD2\_PTOC3****Description:** Time Overcurrent**LN Class:** PTOC

Data Object	CDC type	Description	M/O
<b>Common Logical Node Information</b>			
Beh	ENS	Behavior	M
<b>Status Information</b>			
Str	ACD	Start	M
Op	ACT	Operate	M

**4.14 Logical Node: POLD3\_PTOC4****Description:** Time Overcurrent**LN Class:** PTOC

Data Object	CDC type	Description	M/O
<b>Common Logical Node Information</b>			
Beh	ENS	Behavior	M
<b>Status Information</b>			
Str	ACD	Start	M
Op	ACT	Operate	M

**4.15 Logical Node: IDMT1\_PTOC5****Description:** Time Overcurrent**LN Class:** PTOC

Data Object	CDC type	Description	M/O
<b>Common Logical Node Information</b>			
Beh	ENS	Behavior	M
<b>Status Information</b>			
Str	ACD	Start	M
Op	ACT	Operate	M

#### 4.16 Logical Node: IDMT2\_PTOC6

**Description:** Time Overcurrent

**LN Class:** PTOC

Data Object	CDC type	Description	M/O
<b>Common Logical Node Information</b>			
Beh	ENS	Behavior	M
<b>Status Information</b>			
Str	ACD	Start	M
Op	ACT	Operate	M

#### 4.17 Logical Node: IDMT3\_PTOC7

**Description:** Time Overcurrent

**LN Class:** PTOC

Data Object	CDC type	Description	M/O
<b>Common Logical Node Information</b>			
Beh	ENS	Behavior	M
<b>Status Information</b>			
Str	ACD	Start	M
Op	ACT	Operate	M

#### 4.18 Logical Node: DEF1\_I1\_PTOC8

**Description:** Time Overcurrent

**LN Class:** PTOC

Data Object	CDC type	Description	M/O
<b>Common Logical Node Information</b>			
Beh	ENS	Behavior	M
<b>Status Information</b>			
Str	ACD	Start	M
Op	ACT	Operate	M

#### 4.19 Logical Node: DEF2\_I1\_PTOC9

**Description:** Time Overcurrent

**LN Class:** PTOC

Data Object	CDC type	Description	M/O
<b>Common Logical Node Information</b>			
Beh	ENS	Behavior	M
<b>Status Information</b>			

Str	ACD	Start	M
Op	ACT	Operate	M

#### 4.20 Logical Node: DEF3\_I1\_PTOC10

**Description:** Time Overcurrent

**LN Class:** PTOC

Data Object	CDC type	Description	M/O
<b>Common Logical Node Information</b>			
Beh	ENS	Behavior	M
<b>Status Information</b>			
Str	ACD	Start	M
Op	ACT	Operate	M

#### 4.21 Logical Node: DEF1\_I2\_PTOC11

**Description:** Time Overcurrent

**LN Class:** PTOC

Data Object	CDC type	Description	M/O
<b>Common Logical Node Information</b>			
Beh	ENS	Behavior	M
<b>Status Information</b>			
Str	ACD	Start	M
Op	ACT	Operate	M

#### 4.22 Logical Node: DEF2\_I2\_PTOC12

**Description:** Time Overcurrent

**LN Class:** PTOC

Data Object	CDC type	Description	M/O
<b>Common Logical Node Information</b>			
Beh	ENS	Behavior	M
<b>Status Information</b>			
Str	ACD	Start	M
Op	ACT	Operate	M

#### 4.23 Logical Node: DEF3\_I2\_PTOC13

**Description:** Time Overcurrent

**LN Class:** PTOC

Data Object	CDC type	Description	M/O
<b>Common Logical Node Information</b>			
Beh	ENS	Behavior	M
<b>Status Information</b>			
Str	ACD	Start	M
Op	ACT	Operate	M

**4.24 Logical Node: DEF1\_I3\_PTOC14****Description:** Time Overcurrent**LN Class:** PTOC

Data Object	CDC type	Description	M/O
<b>Common Logical Node Information</b>			
Beh	ENS	Behavior	M
<b>Status Information</b>			
Str	ACD	Start	M
Op	ACT	Operate	M

**4.25 Logical Node: DEF2\_I3\_PTOC15****Description:** Time Overcurrent**LN Class:** PTOC

Data Object	CDC type	Description	M/O
<b>Common Logical Node Information</b>			
Beh	ENS	Behavior	M
<b>Status Information</b>			
Str	ACD	Start	M
Op	ACT	Operate	M

**4.26 Logical Node: DEF3\_I3\_PTOC16****Description:** Time Overcurrent**LN Class:** PTOC

Data Object	CDC type	Description	M/O
<b>Common Logical Node Information</b>			
Beh	ENS	Behavior	M
<b>Status Information</b>			
Str	ACD	Start	M
Op	ACT	Operate	M

**4.27 Logical Node: RBRF1****Description:** Breaker Failure**LN Class:** RBRF

Data Object	CDC type	Description	M/O
<b>Common Logical Node Information</b>			
Beh	ENS	Behavior	M
<b>Status Information</b>			
OpEx	ACT	Breaker Failure External Trip	M



**4.28 Logical Node: RDRE1****Description:** Disturbance Recorder Function**LN Class:** RDRE

Data Object	CDC type	Description	M/O
<b>Common Logical Node Information</b>			
Beh	ENS	Behavior	M
<b>Status Information</b>			
RcdMade	SPS	TRUE = disturbance recording complete	M
FltNum	INS	Fault Number	M

## 5. Enum types

Enum types are listed in this clause.

### 5.1 Mod

Value	Description
1	on
2	blocked
3	test
4	test/blocked
5	off

### 5.2 ctlModel

Value	Description
0	status-only
1	direct-with-normal-security
2	sbo-with-normal-security
3	direct-with-enhanced-security
4	sbo-with-enhanced-security

### 5.3 Health

Value	Description
1	Ok
2	Warning
3	Alarm



## **ALUMINIUM INDUSTRIES LTD**

**Relays division, Kavinpuram, Vilappilsala (P.O)  
Thiruvananthapuram, Kerala, India-695 573**

**☎: 0471-2379704, 2379503**

**🌐: [www.alindrelays.com](http://www.alindrelays.com)**

**✉: [contact@alindrelays.com](mailto:contact@alindrelays.com) (enquiry)**

**✉: [service@alindrelays.com](mailto:service@alindrelays.com) (service)**